



**Różne opakowania,  
jeden dostawca**

**A range of packaging solutions  
from a single source**



**FEFCO**  
**katalog opakowań**  
**Fibreboard case code**



## Spis treści













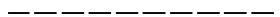

1. Katalog opakowań - wprowadzenie .....	str. 2
2. Fibreboard case code - introduction .....	str. 6
3. Katalog/Catalouge .....	str. 10

# Międzynarodowy katalog opakowań

Niniejszy katalog został opracowany przez FEFCO i ESBO jako oficjalny system, mający zastąpić długie i skomplikowane opisy konstrukcji opakowań z tekury prostymi symbolami powszechnie rozumianymi w skali międzynarodowej, niezależnie od różnic językowych.

Odesłania mogą być stosowane w zamówieniach i specyfikacjach dotyczących opakowań. Zmian i uzupełnień mogą dokonywać jedynie FEFCO i ASSCO.

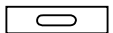
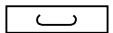
## Symbol używane na rysunkach i w systemach komputerowych

Symbol	Kod komputerowy	Opis
<b>Linie cięcia, bigowania</b>		
	CL	Linia cięcia wykrojów opakowań
	S.C.	Wycięte szczeliny
	CI	Linie bigowania (zagięcia do wewnątrz)
	CO	Linie bigowania (zagięcia na zewnątrz)
	SI	Linie nacięć (zagięcie do wewnątrz)
	SO	Linie nacięć (zgięcie na zewnątrz)
	DS	Podwójne linie bigowania
	PL	Perforacja
	SE	Nóż falowany
	TP	Perforacja do zrywania (jodelka)
<b>Sposoby łączenia opakowań</b>		
	SJ	Połączenie przez zszycie drutem
	TJ	Połączenie taśmą klejącą
	GJ	Połączenie przez sklejenie
<b>Uchwyty</b>		
	PC	Uchwyt wycięty (otwór)
	UC	Uchwyt niewycięty (z bigiem)
	NC	Uchwyt niewycięty (z bigiem)
<b>Kierunek fali</b>		
	FD	Oznaczenie kierunku fali

## Wykroje opakowań w niniejszym katalogu postrzegane są od strony wewnętrznej

### Wymiary pudeł

O ile nie wskazano inaczej, wszystkie wymiary wyrażono jako wymiary wewnętrzne w mm, jak następuje:

Długość (L) x Szerokość (B) x Wysokość (H).

Długość (L) = dłuższy z wymiarów w ustawieniu do otwarcia opakowania.

Szerokość (B) = krótszy z wymiarów w ustawieniu do otwarcia opakowania.

Wysokość (H) = wymiar pomiędzy podstawą a górą opakowania.

Wymiary L, B, H podaje się w każdym opisie konstrukcji pudeła, przy czym w przypadku niektórych modeli wartość liczbową B może przekraczać wartość liczbową L.

Wymiary należy ustalać w standardowych warunkach klimatycznych, na rozłożonym wykroju od środka bigu, uwzględniając grubość materiału.

W przypadku pudeł teleskopowych wysokość (h) górnej części (pokrywy) powinna być podawana jako czwarty wymiar, po ukośniku, np.:

355 x 205 x 120/40 mm  
(L) (B) (H) (h)

W przypadku pudeł z nachodzącymi na siebie klapami zewnętrznymi długość nachodzenia (o) powinna być podawana jako czwarty wymiar, po ukośniku, np.:

355 x 205 x 120/40 mm  
(L) (B) (H) (o)

### Wymiary arkuszy

O ile nie podano inaczej, wymiary arkuszy tektury falistej podaje się w mm, jak następuje:

1 wymiar x 2 wymiar

1 wymiar = wzdłuż kierunku fali

2 wymiar = w poprzek kierunku fali

### Wersje standardów

Dla kilku typów pudeł istnieją wersje pochodne, bez potrzeby tworzenia nowego standardu. W takich przypadkach należy dodawać rozszerzenie do podstawowego numeru standardu, oddzielając go myślnikiem.

Przykład: 0201-2

Wersja taka może u danego producenta mieć charakter indywidualny.

### Łączenie standardów

Przedstawione standardy konstrukcji stanowią podstawowe typy pudeł z tektury. Jeśli konstrukcja ostateczna jest kombinacją dwóch lub trzech modeli podstawowych, np. z zastosowaniem klap, może ona także zostać opisana jak następuje:

Klapy góry jak w 0204, klapy spodu jak w 0215

Typ ten może również zostać opisany jako 0204/0215 (klapy góry, klapy spodu).

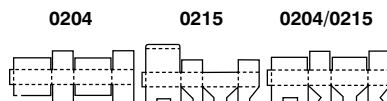

### Rodzaje łączenia pudeł

Układy pokazane na rysunkach w niniejszym katalogu mogą być zmieniane stosownie do wybranego przez producenta łączenia. W niektórych konstrukcjach połączenia te mogą polegać na klejeniu, stosowaniu taśmy klejącej albo szyciu. Klapka przeznaczona do klejenia lub szycia może być przy dłuższym lub krótszym boku. Poniższe szkice demonstrują, w jaki sposób połączenia takie mogą zostać wskazane na rysunku:

Przykład dotyczący wszystkich konstrukcji:

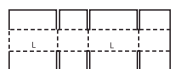

Połączenie taśmą klejącą

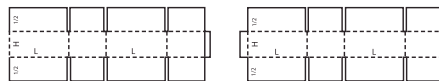

Połączenie klejone albo szyte

Dotyczy to wszystkich wzorów objętych niniejszym katalogiem.

### Składanie ręczne lub automatyczne

Każda konstrukcja opakowania ma jedną z następujących cech:

M - zwykle składanie ręczne

A - zwykle składanie automatyczne

M/A - oznacza, że składanie ma charakter ręczny lub automatyczny, M+A wymaga połączenia obydwu rodzajów.

Wskazania te oparte są na aktualnej praktyce, a ich celem jest przekazanie dodatkowej informacji tym, którzy tworzą specyfikacje oraz użytkownikom. Niektóre z ręcznie składanych pudeł mogą być zamykane automatycznie (np.: 0216 albo 0712).

# Opis podstawowych rodzajów konstrukcji\*

\* Określenia pudło, pojemnik i skrzynka mają, w kontekście tych opisów, charakter zamienny.

## Uwagi ogólne

Należy zwrócić uwagę, że kilka wzorów pudeł, zawartych w katalogu pod danym numerem może zostać również sklasyfikowanych w ramach innych podstawowych typów grup.

## 01 - Rolki i arkusze stosowane w handlu

## 02 - Pudła klapowe

Pudełka klapowe są to pudełka złożone zasadniczo z jednej części, których brzeg jest klejony, szyty, albo które mają połączenie taśmą klejącą oraz posiadają górne i dolne klapy. Producent wysyła je złożone na płask, gotowe do użycia, a zamyka przy zastosowaniu klap.

## 03 - Pudła teleskopowe

Pudła teleskopowe składają się z więcej niż jednej części i charakteryzuje je istnienie wieka i/lub spodu, które zachodzą teleskopowo na siebie.

## 04 - Pudła składane i tace

Pudła składane i tace, zwykle składają się tylko z jednego formatu. Dno pudła składa się tak, by utworzyć dwie lub więcej ścian bocznych oraz pokrywę. W niektórych wzorach mogą się pojawiać zamknięcia, uchwyty, okienka itd.

## 05 - Pudła wsuwane

Pudełka te składają się z większej ilości części (wewnętrznych oraz obwolut), które można w różnych kierunkach wsuwać jedno w drugie. Grupa ta obejmuje także obwoluty dla innych pudeł.

## 06 - Pudełka trwale łączone

Pudełka trwale łączone składają się z dwóch oddzielnych części końcowych oraz korpusu i wymagają, przed ich użyciem, szycia albo podobnej operacji.

## 07 - Pudełka klejone jednoczęściowe

Są to pudełka klejone, złożone zwykle z jednej części, dostarczane w stanie złożonym i gotowe do użycia po ich prostym rozłożeniu.

## 09 - Wyposażenie wewnętrzne

Wyposażenie wewnętrzne pudeł, takie jak wkładki, przekładki, kratownice, wkładki wypełniające itd., stanowiące elementy związane z konstrukcją pudła albo osobne. Wskazana ilość elementów jest dowolna i może być, stosownie od wymagań, zwiększana lub zmniejszana.

## Podawanie kodu stylu

Kod pełny: XXXX - XXXX	
Standard	Wersja standardu
XXXX	- XXXX
Standardowy uznany kształt/wzór dla tego kodu	Numer wersji, służący odróżnieniu odchylenia od wzoru standardowego (odpowiadający indywidualnemu rysunkowi albo elementowi biblioteki CAD/CAM)

## Zamknięcia pudeł

Właściwe i skuteczne zamknięcia opakowań są równie ważne jak sama konstrukcja opakowania.

Następujące rodzaje zamknięć możliwe są albo pojedynczo, albo w połączeniu z innymi:

- klejenie na zakładkę, na zimno lub gorąco
- klejenie taśmą klejącą
- zablokowanie
- szycie drutem.

### Łączenie taśmą klejącą

Wykonuje się je stosownie do pokazanych niżej przykładów.

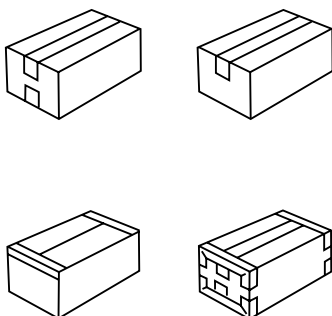

### Szycie drutem

Wykonuje się je stosownie do pokazanych niżej przykładów.



## Kodowanie wyposażenia

Następujący zakres elementów wyposażenia wewnętrznego podlega kodowaniu w zależności od liczby zastosowanych elementów, w dowolnej kombinacji kształtów (dla systemów komputerowych).

Liczba elementów		KOD
2	>	0982
3	>	0983
4	>	0984
5	>	0985
6	>	0986
7	>	0987
8	>	0988
9	>	0989
10	>	0990
11	>	0991
12	>	0992
13	>	0993
14	>	0994
15	>	0995
16	>	0996
17	>	0997
18	>	0998
19	>	0999

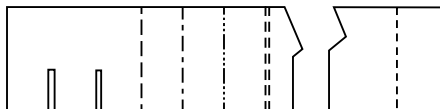















0982/0999  
M

# International fibreboard case code

This Code has been developed by FEFCO and ESBO as an official system to substitute long and complicated verbal descriptions of fibreboard case and packaging constructions with simple symbols internationally understood by all, regardless of language and other differences.

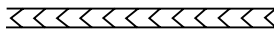
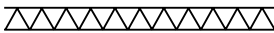
The references may be used in orders and specifications for packing cases. Additions and modifications may only be made by FEFCO and ESBO.

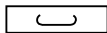
## Symbols used in drawings and computer systems

Drawing symbol	Computer code	Description
<b>Cuts, scores, slits etc.</b>		
	CL	contours of erected cases or cuttinglines of case blanks
	S.C.	slotted cuts
	CI	crease lines (inward bend)
	CO	crease lines (outward bend)
	SI	slit-score lines (inward bend)
	SO	slit-score lines (outward bend)
	DS	double-score lines
	PL	perforation lines
	SE	soft edge cutting lines
	TP	tear perforation
<b>Manufacturer's joint</b>		
	SJ	stitched joint
	TJ	taped Joint
	GJ	glued joint
<b>Openings</b>		
	PC	handholds stripped
	UC	handholds non-stripped
	NC	handholds non-stripped
<b>Flute direction</b>		
	FD	flute direction indicator



**The layouts of the styles in this Code are always viewed from the inside of the case.**

**Case dimensions**

Unless otherwise specified all dimensions are expressed as internal dimensions in mm as follows:

Length (L) x Breadth (B) x Height (H)  
 Length (L) = the longer dimension at the opening  
 Breadth (B) = the shorter dimension at the opening  
 Height (H) = the dimension from the top of the opening to the base.

The dimensions L, B, H are specified in each description of the case construction, for some models the numerical value of B can exceed the numerical value of L.

Dimensions should be measured under standard climatic conditions, on the flat blank from the centre of crease bearing the thickness of the material in mind.

For telescope-type boxes the height (h) of the upper part (lid) should be given as a fourth measurement after an oblique stroke, i.e.

355 x 205 x 120/40 mm  
 (L) (B) (H) (h)

For cases with overlapping outer flaps the length of the area of overlapping (o) should be given as a fourth measurement after an oblique stroke, i.e.

355 x 205 x 120/40 mm  
 (L) (B) (H) (o)

**Sheet dimensions**

Unless otherwise specified, the dimensions of a corrugated sheet are expressed in mm as follows:

1<sup>st</sup> dimension x 2<sup>nd</sup> dimension  
 1<sup>st</sup> dimension = along the glue lines  
 2<sup>nd</sup> dimension = across the glue lines

**Style versions**

Several case types may have derived versions without the necessity to create a new style. In this case a suffix should be added to the basic style number, separated by a dash.

Example: 0201-2.

A version may be unique to individual manufacturers.

**Combination of types**

The construction styles shown are of the basic types of fibreboard cases. If the ultimate construction is a combination of two or three basic models, e.g. flap arrangements, they may also be described as follows:

Top flaps as 020, Bottom flaps as 0215

This type may also be described as 020/0215 (Top flaps. Bottom flaps).

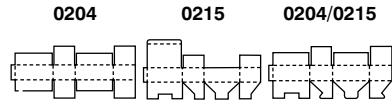

**Styles and the manufacturers joint**

The drawing style layouts as shown in this Code may need to be re-arranged depending on the Manufacturers Joint chosen. Some styles may have a Manufacturers Joint which may be glued, stitched or taped. A glued or stitched Joint may be an extension of either the short or the long panel. The sketches show how these would be indicated on a drawing:

Example for all styles:



Taped joint

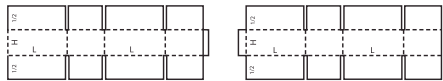

Glued or stitched joint

This applies to all designs in this Code.

**Manual or Automated erection**

Each design style includes one of the following indications:

- M - usually manual erection
- A - usually automated erection
- M/A - can be either manual or automated M+A - requires a combination of both.

This indications are based on current practice and are intended to give additional information to specifiers and users. Some manually erected cases can be closed automatically (e.g: 0216 or 0712).

# Description of basic type groups\*

\*The terms Box, Container and Case are interchangeable in the context of these descriptions.

## General remarks

Please note that several case designs contained in the Code under a specific number could also be classified under other basic type groups.

## 01 - Commercial rolls and sheets

## 02 - Slotted-type boxes

Slotted-type boxes consist of basically one piece with a glued, stitched or taped manufacturers joint and top and bottom flaps. They are shipped flat, ready to use and require closing using the flaps provided.

## 03 - Telescope-type boxes

Telescope-type boxes consist of more than one piece and are characterised by a lid and/or bottom telescoping over the body of the box.

## 04 - Folder-type boxes and trays

Folder-type boxes and trays usually consist of only one piece of board. The bottom of the box is hinged to form two or all side walls and the cover. Locking tabs, handles, display panels etc., can be incorporated in some designs.

## 05 - Slide-type boxes

Slide-type boxes consist of several pieces of liners and sleeves sliding in different directions into each other. This group also includes outside sleeves for other cases.

## 06 - Rigid-type boxes

Rigid-type boxes consist of two separate end pieces and a body and require stitching or a similar operation before they can be used.

## 07 - Ready-glued cases

Ready-glued cases consist of basically one piece, are shipped flat and ready to use by simple setting up.

## 09 - Interior fitments

Interior fitments such as inside liners, pads, partitions, dividers etc., whether tied to Case Design or as singular items. Any shown number of panels is arbitrary and may be increased or decreased as required.

## Writing of the style code

Full code: XXXX - XXXX	
Style	Style version
XXXX	- XXXX
The standard recognised shape/design from this code.	The version number to differentiate the variation from the standard design (corresponding to an individual drawing or CAD/CAM library).

## Closure of boxes

Correct and effective closure of the packages is as important as the packaging construction itself.

The following methods of closure are possible either singly or in combination:

- by gluing, cold or hot
- by taping
- by interlocking
- by stitching

### Closing by taping

This can be done according to the examples shown.

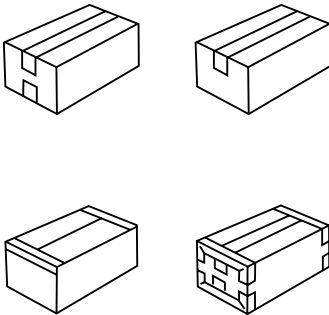

### Closing by stitching

This can be done according to the examples shown..



## Coding of interior fitments

The following range of interior fitments is coded depending on the number of panels used, in any combination of shapes (for computer systems).

Number of panels		CODE
2	>	0982
3	>	0983
4	>	0984
5	>	0985
6	>	0986
7	>	0987
8	>	0988
9	>	0989
10	>	0990
11	>	0991
12	>	0992
13	>	0993
14	>	0994
15	>	0995
16	>	0996
17	>	0997
18	>	0998
19	>	0999

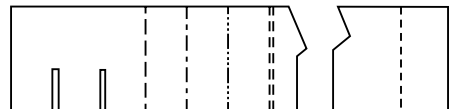

0982/0999  
M

# 0100

- ▲ Rolki i arkusze stosowane w handlu
- ▲ Commercial rolls and sheets

## 0100

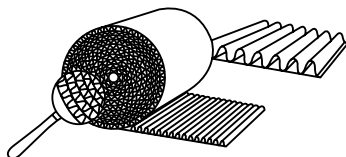

## 0110

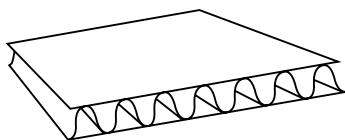

# 0200

▲ **Pudła klapowe** są to pudełka złożone zasadniczo z jednej części, których brzeg jest klejony, szyty, albo które mają połączenie taśmą klejącą oraz posiadają górne i dolne kłapy. Producent wysyła je złożone na płask, gotowe do użycia, a zamyka przy zastosowaniu kłap.

▲ **Slotted-type boxes** consist of basically one piece with a glued, stitched or taped manufacturers joint and top and bottom flaps. They are shipped flat, ready to use and require closing using the flaps provided.

## 0200

M/A

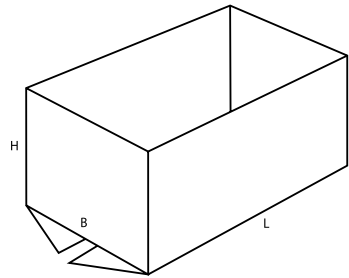
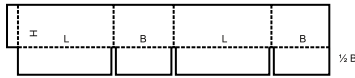

## 0201

M/A

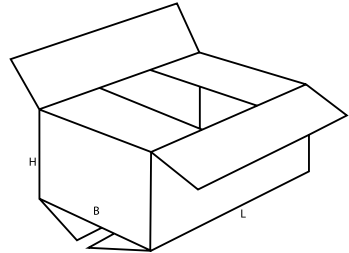
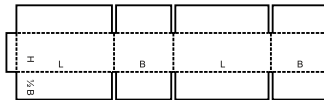

## 0202

M/A

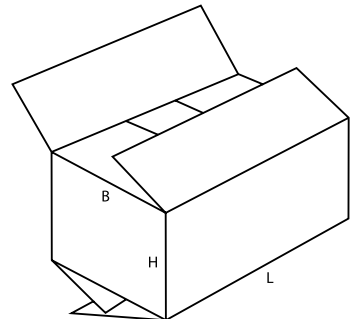
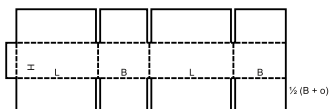

0203

M/A

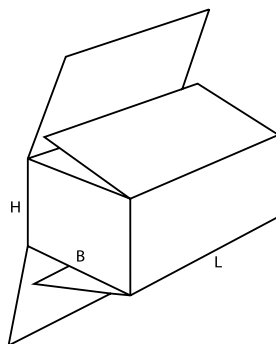
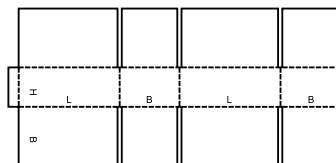

0204

M/A

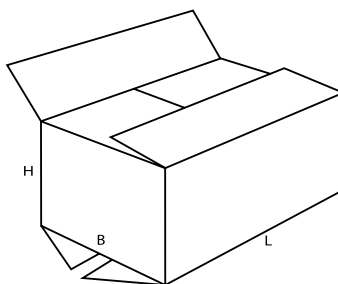
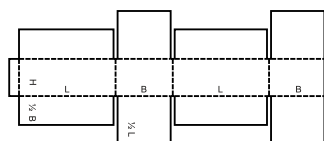

0205

M/A

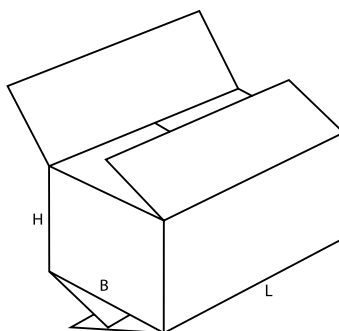
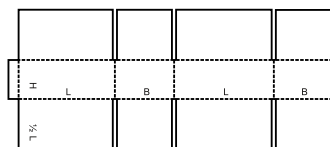

0206

M/A

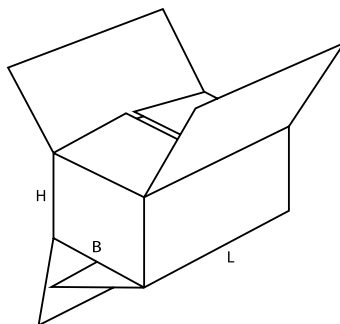
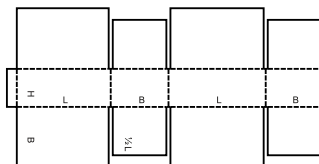

0207

M

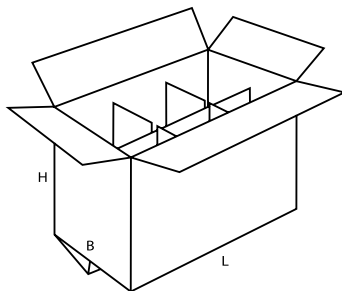
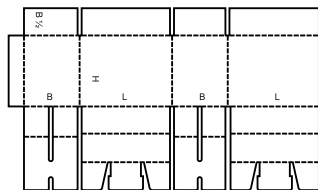

0208

M

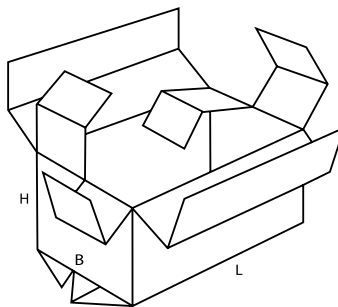
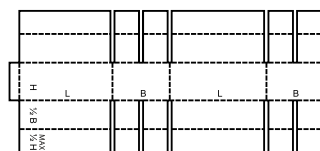

0209

M/A

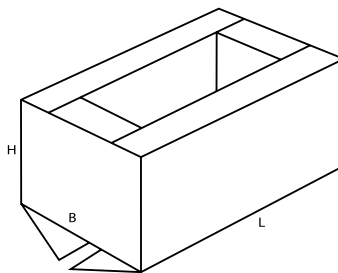
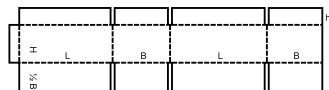

0210

M

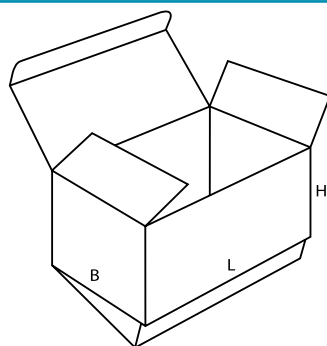
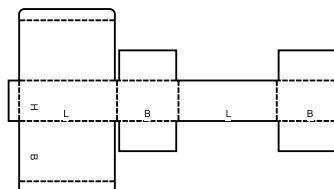

0211

M

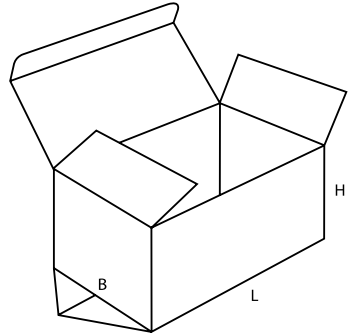
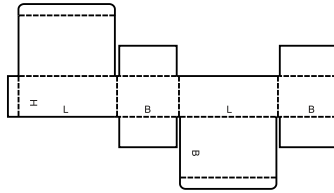

0212

M/A

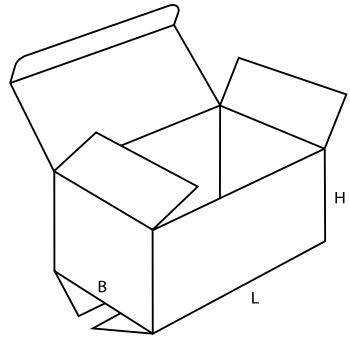
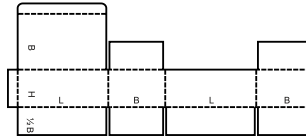

0214

M

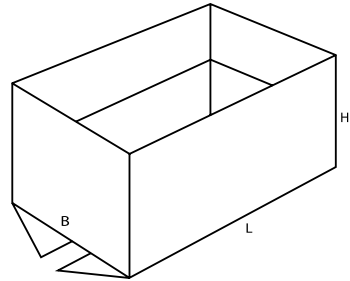
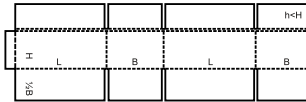

0215

M

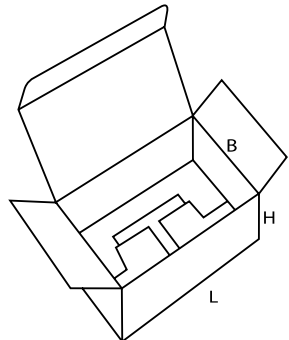
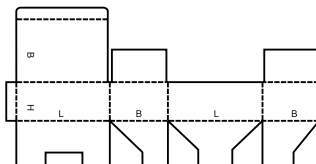



0216

M

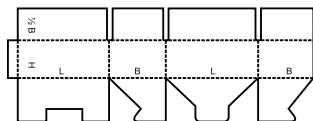

closure of top can be automated

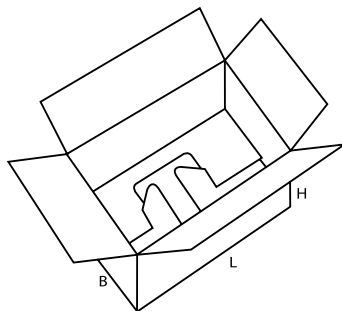

0217

M

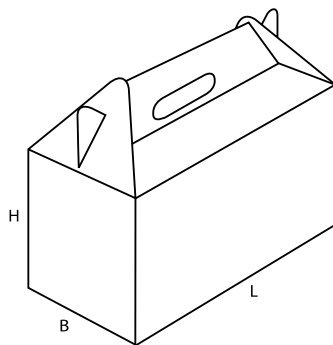
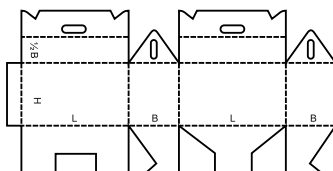

0218

M

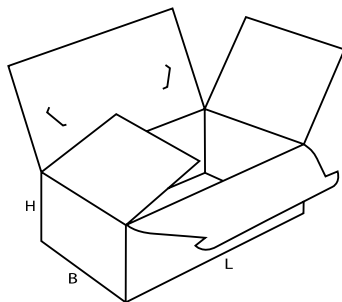
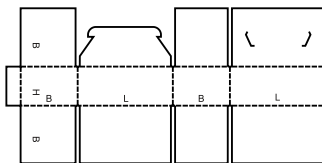

0225

M

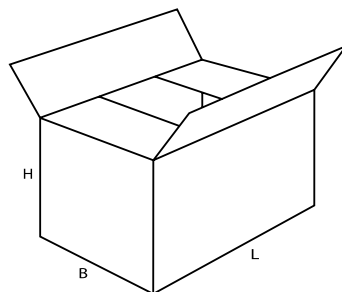
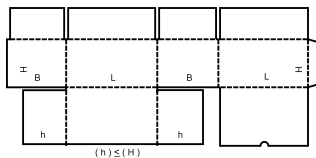

0226

M

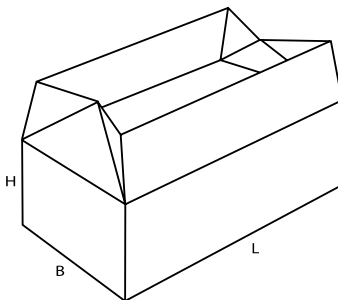
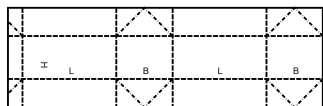

0227

M

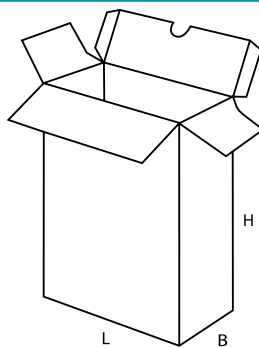
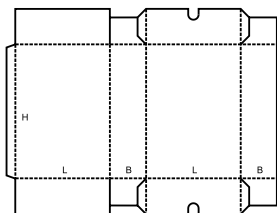

0228

M/A

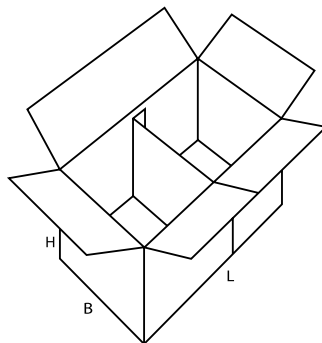
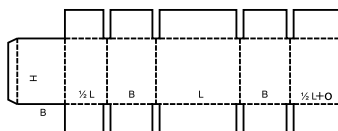

0229

M

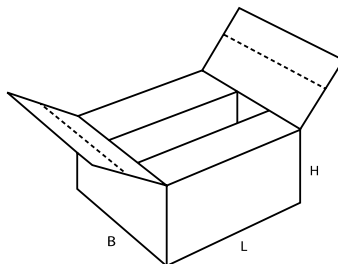
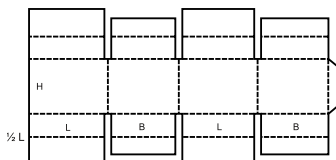

0230

M/A

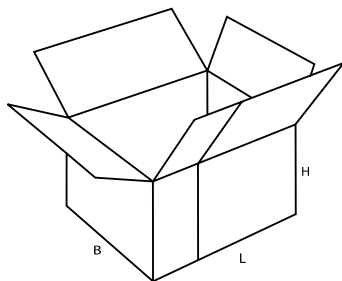
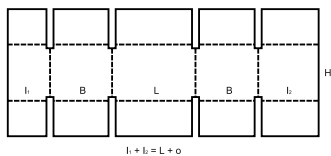

0231

M/A

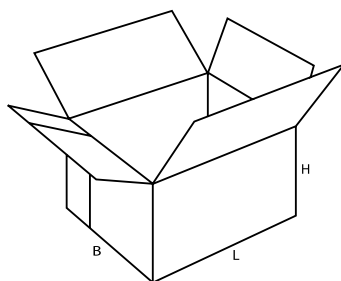
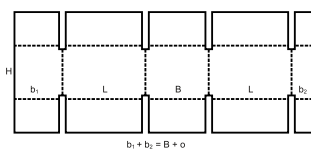

# 0300

▲ **Pudła teleskopowe** składają się z więcej niż jednej części i charakteryzuje je istnienie wieka i/lub spodu, które zachodzą teleskopowo na siebie.

▲ **Telescope-type boxes** consist of more than one piece and are characterised by a lid and/or bottom telescoping over the body of the box.

## 0300

M/A

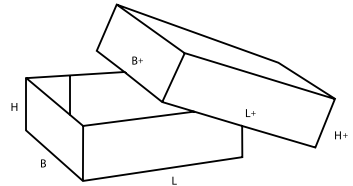
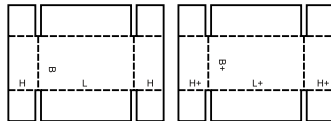

## 0301

M/A

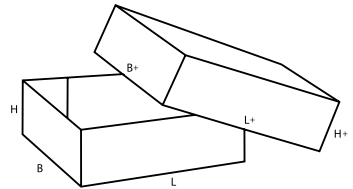
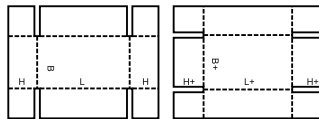

## 0302

M

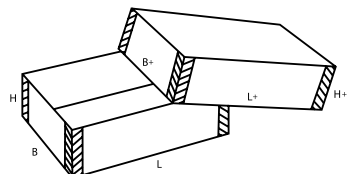
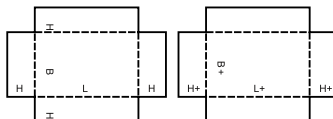

0303

M

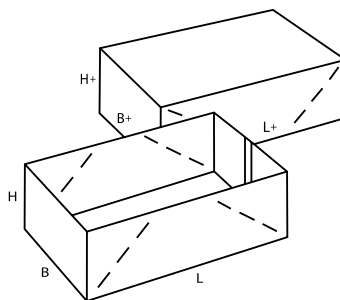
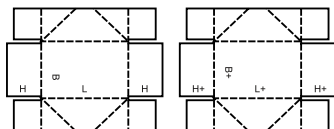

0304

M

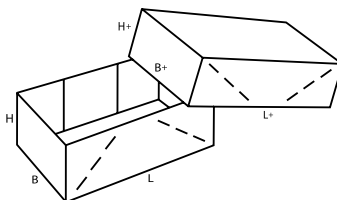
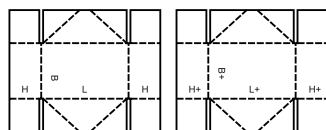

0306

M/A

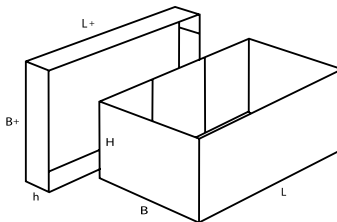
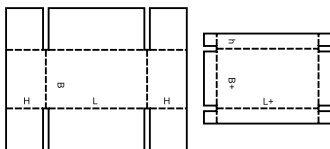

0307

M

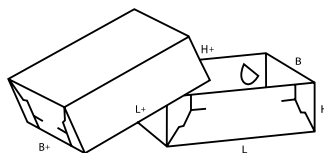
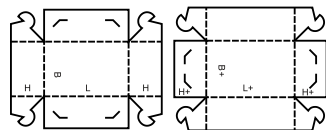

0308

M

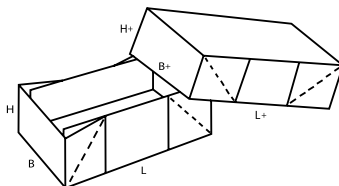
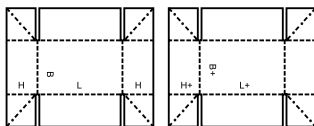

0309

M

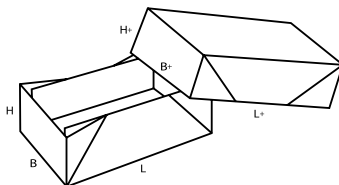
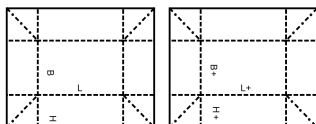

0310

M+A

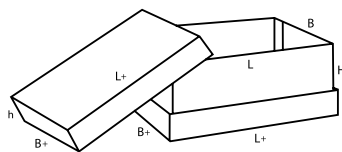
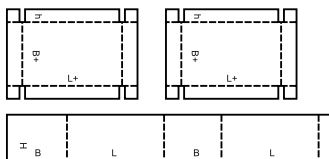

0312

M/A

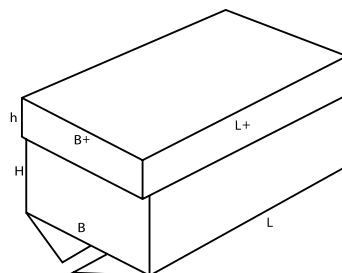
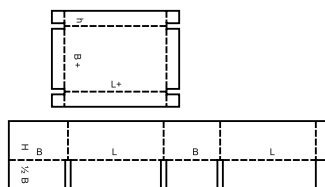

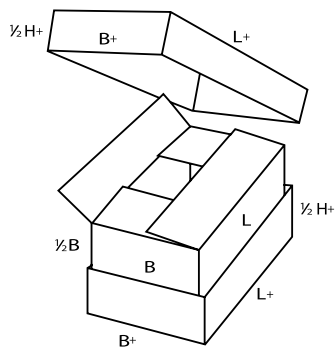
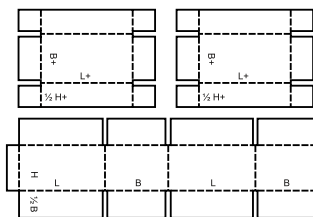
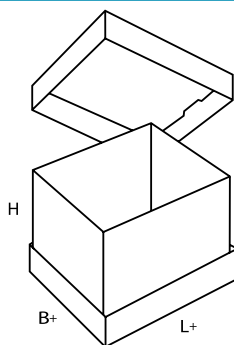
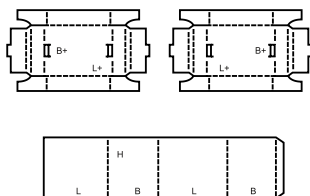
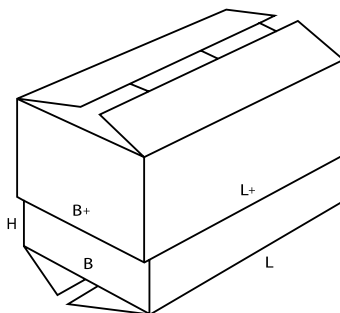
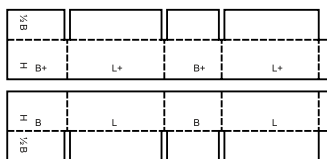
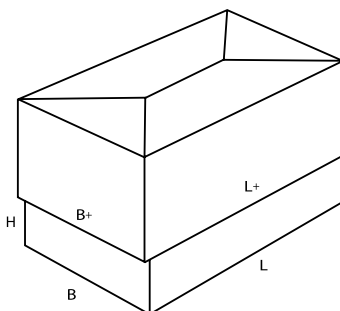
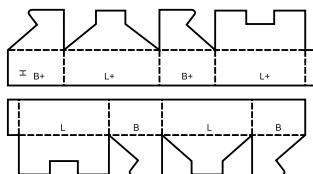
**0313****M/A****0314****M****0320****M/A****0321****M**

0322

M

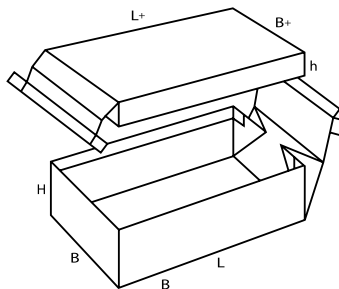
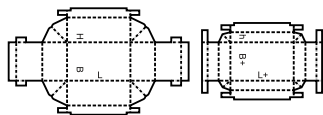

0323

M

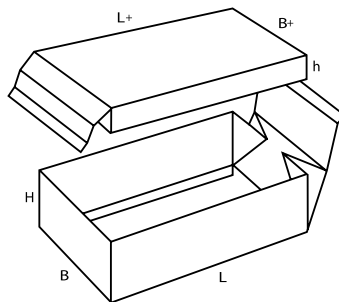
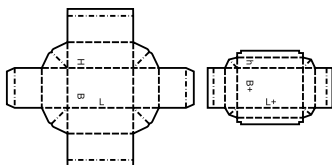

0325

A

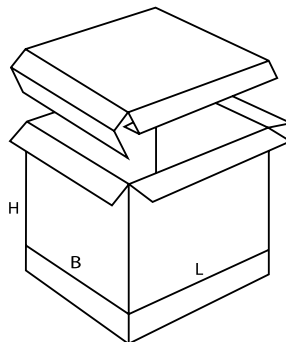
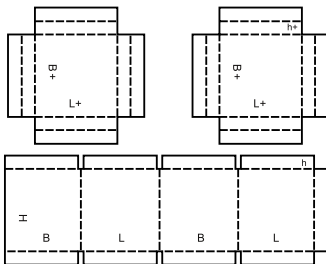

0330

M/A

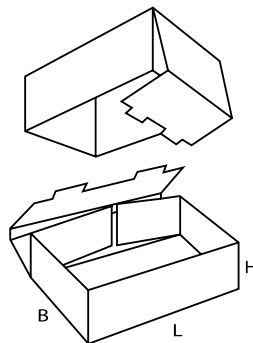
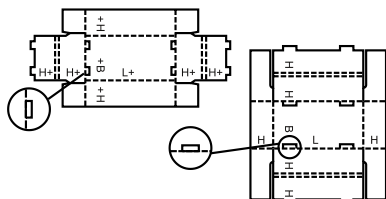



0331

M/A

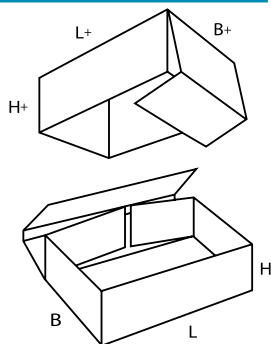
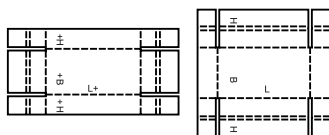

0350

M

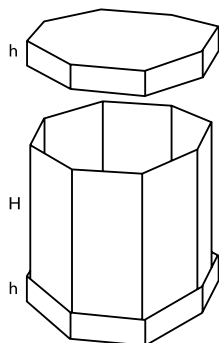
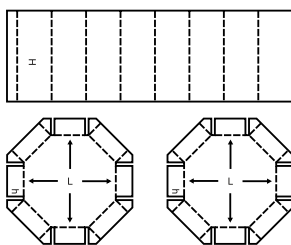

0351

M/A

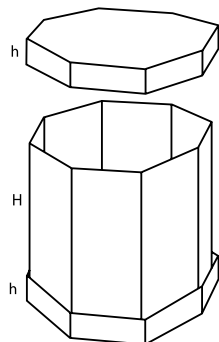
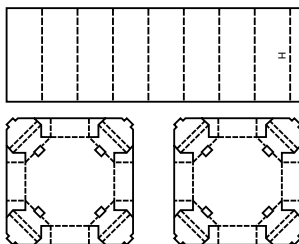

0352

M/A

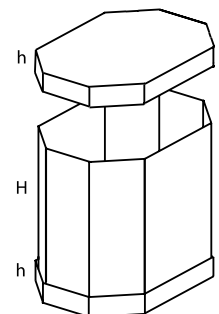
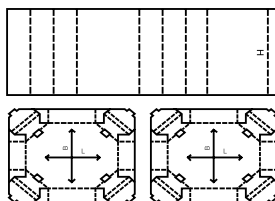

# 0400

▲ **Pudła składane i tace** zwykle składają się tylko z jednego formatu. Dno pudła składa się tak, by utworzyć dwie lub więcej ścian bocznych oraz pokrywę. W niektórych wzorach mogą się pojawiać zamknięcia, uchwyty, okienka itd.

▲ **Folder-type boxes** and trays usually consist of only one piece of board. The bottom of the box is hinged to form two or all side walls and the cover. Locking tabs, handles, display panels etc., can be incorporated in some designs.

## 0400

M

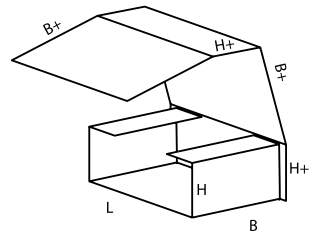
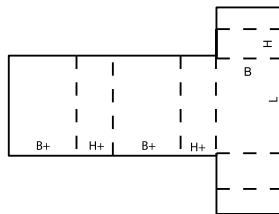

## 0401

M

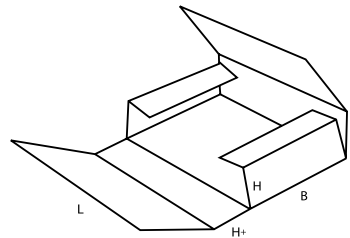
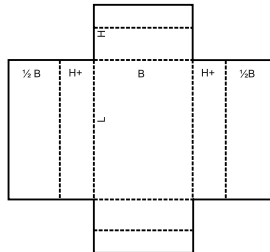

## 0402

M

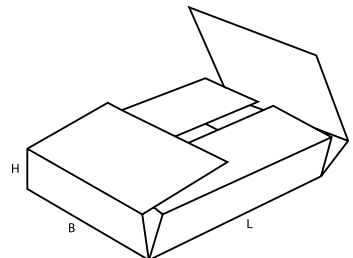
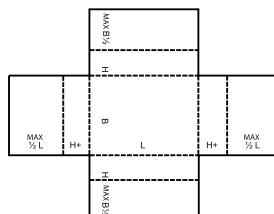

0403

M

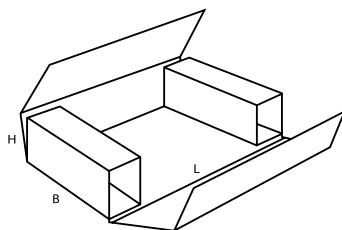
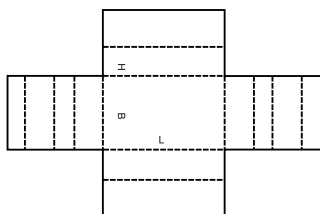

0404

M

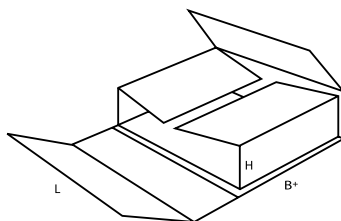
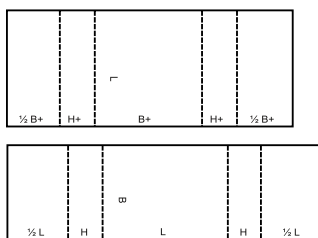

0405

M

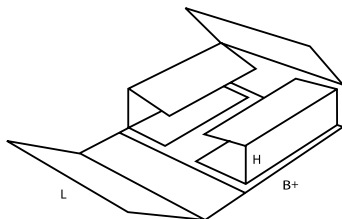
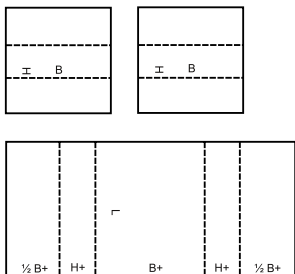

0406

A

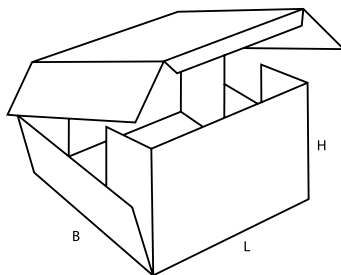
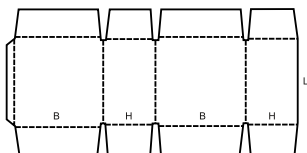

0409

M

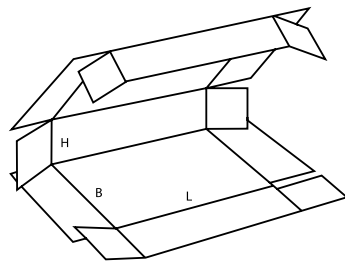
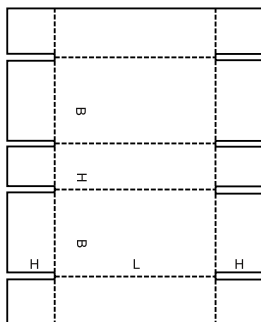

0410

M/A

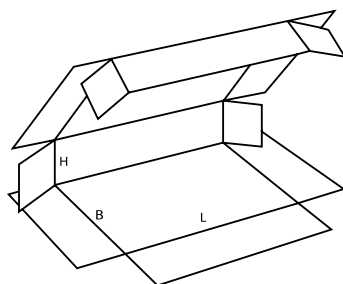
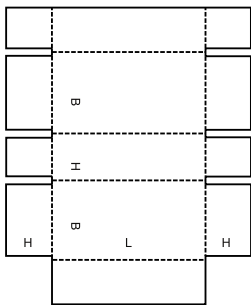

0411

M/A

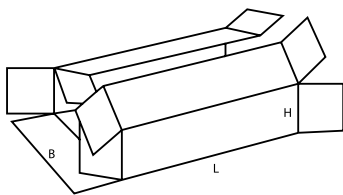
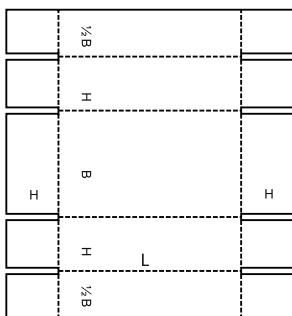

0412

M

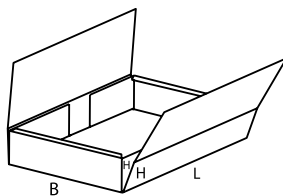
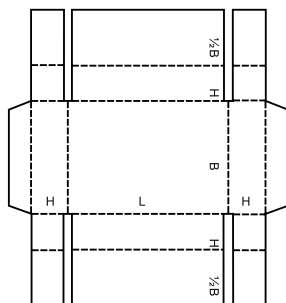

0413

M/A

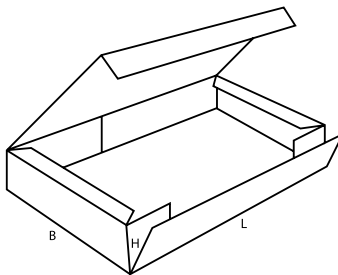
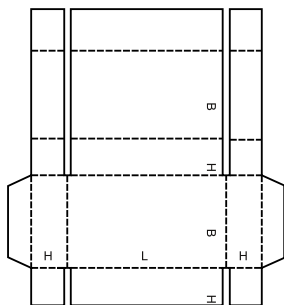

0415

M/A

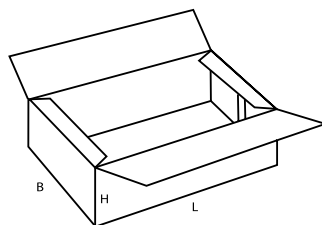
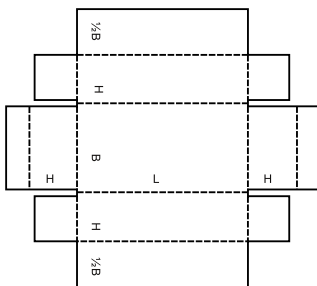

0416

M

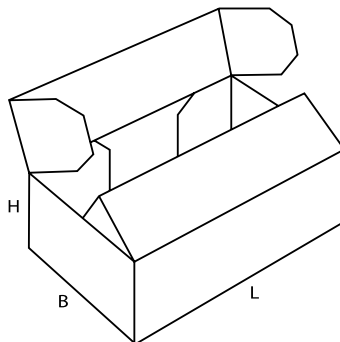
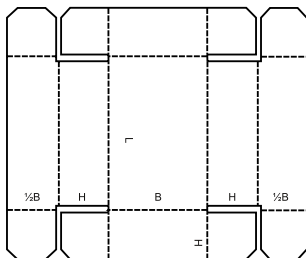

0420

M/A

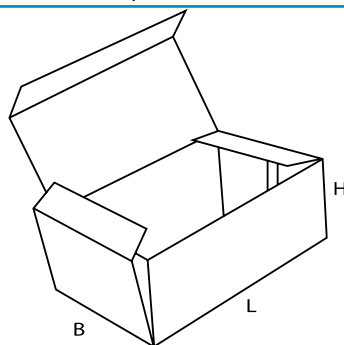
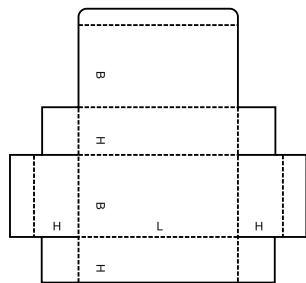

0421

M/A

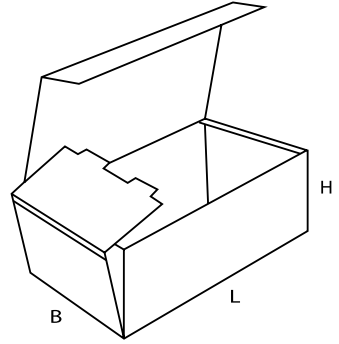
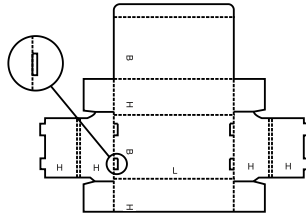

0422

M/A

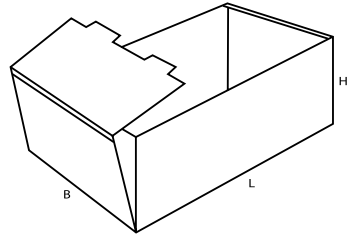
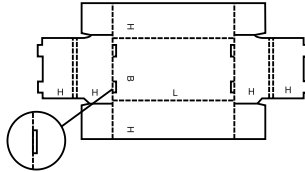

0423

M/A

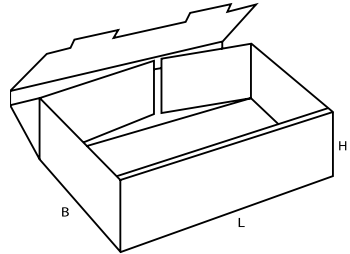
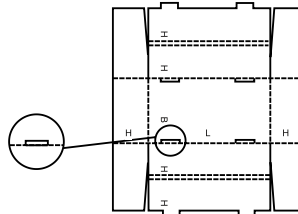

0424

M/A

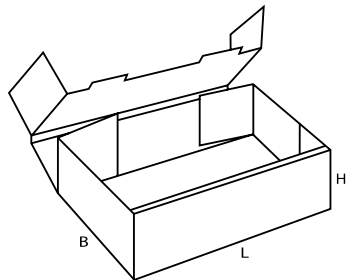
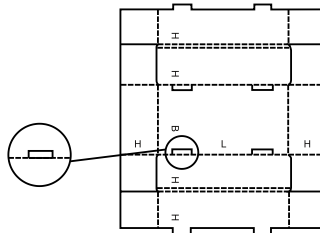

0425

M/A

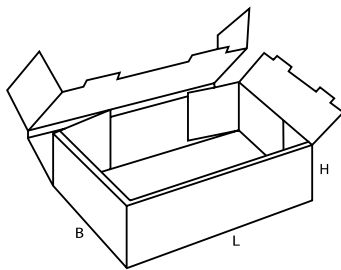
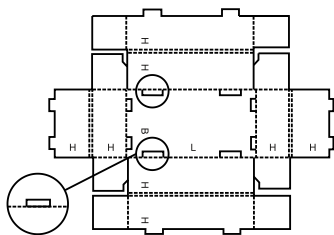

0426

M

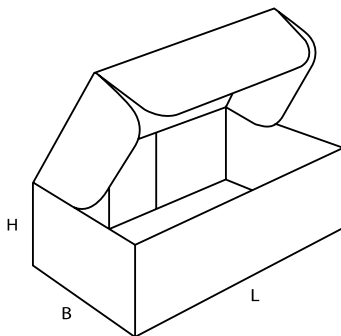
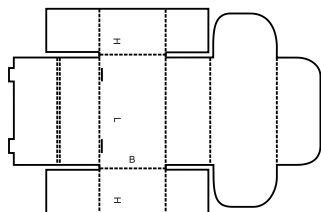

0427

M

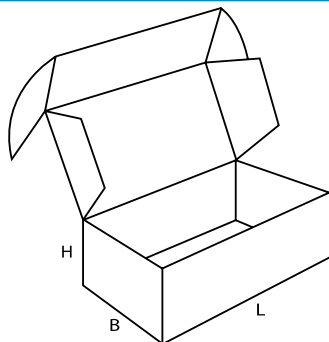
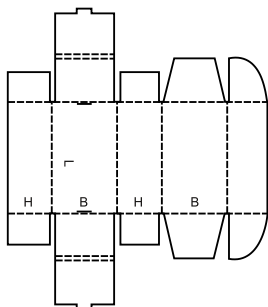

0428

M

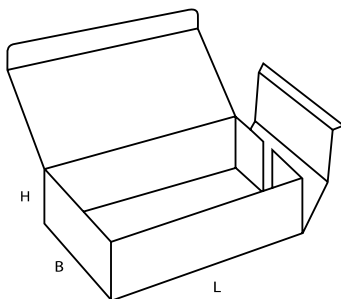
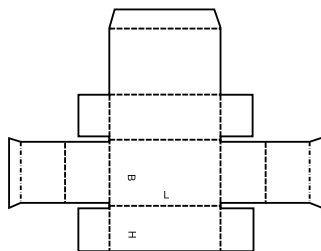

0429

M

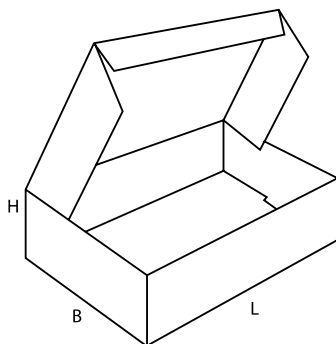
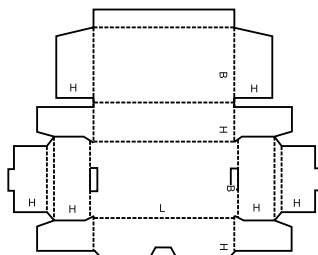

0430

M/A

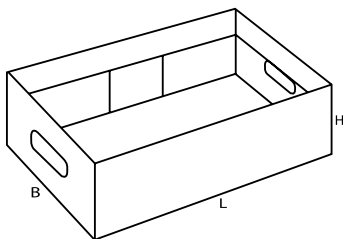
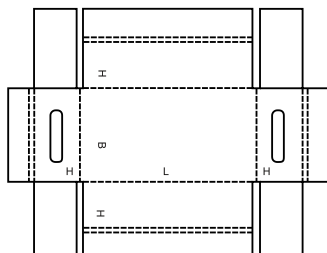

0431

M

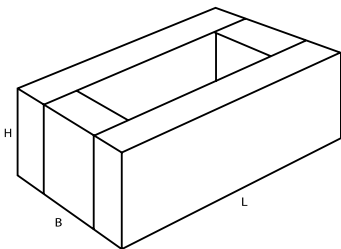
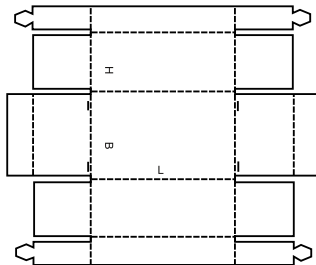

0432

M

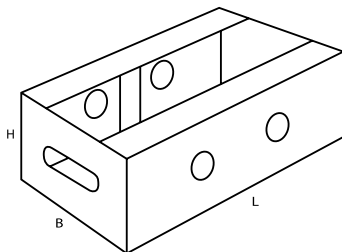
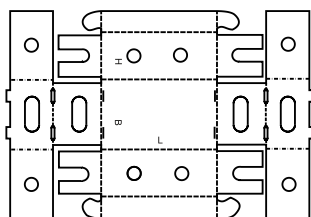



0433

M

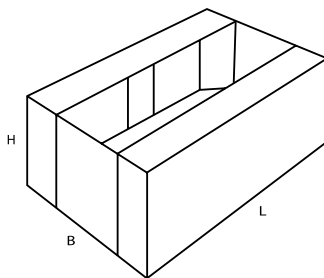
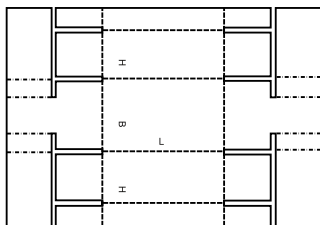

0434

M

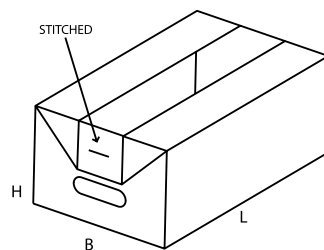
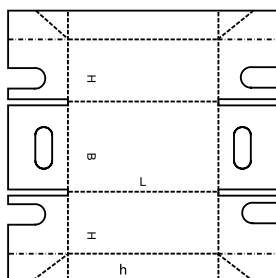

0435

M/A

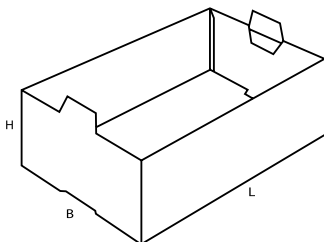
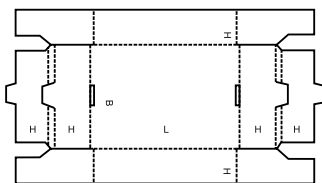

0436

M

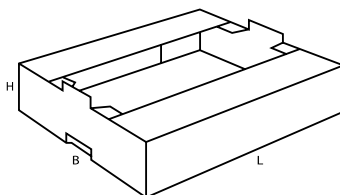
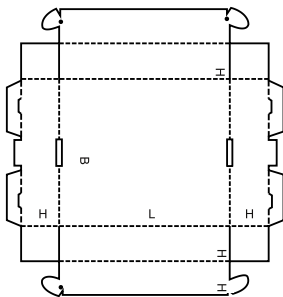

0437

M

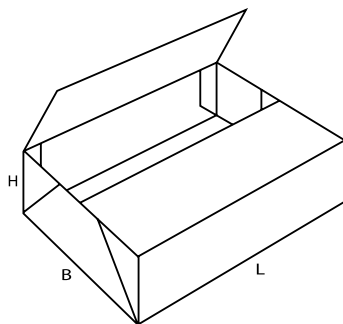
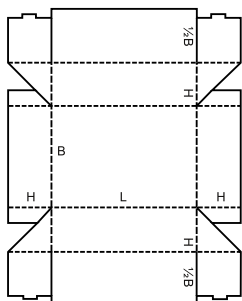

0440

A

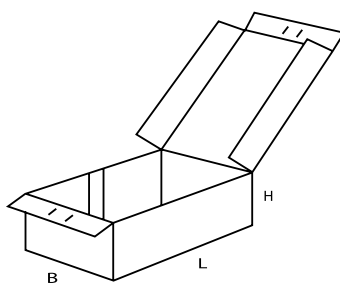
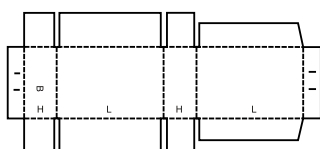

0441

A

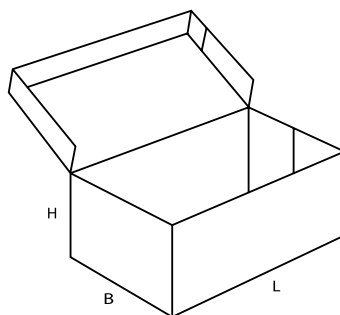
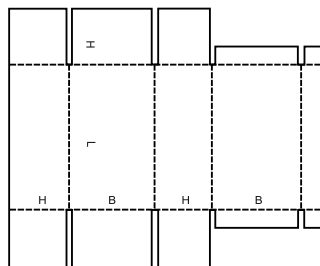

0442

M

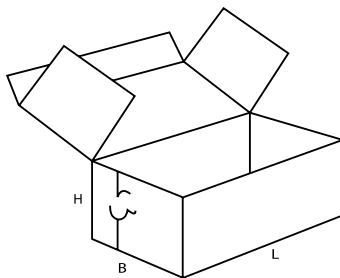
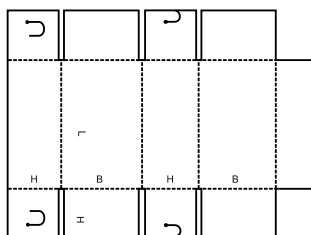

0443

M

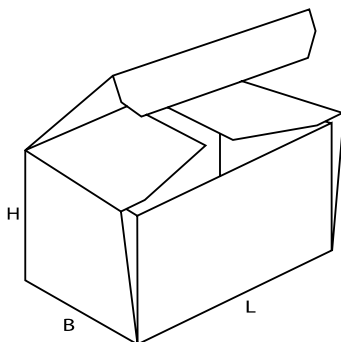
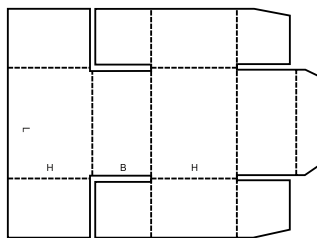

0444

M

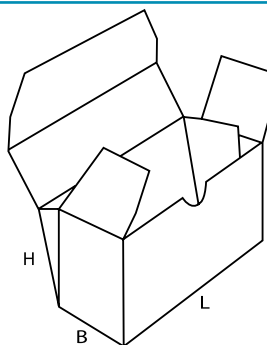
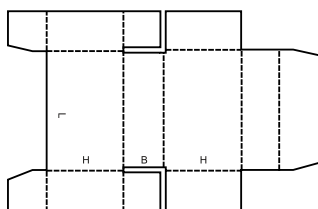

0445

M

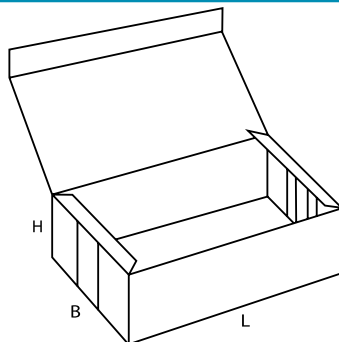
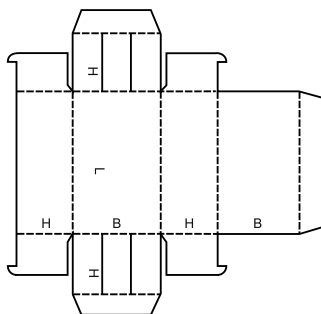

0446

A

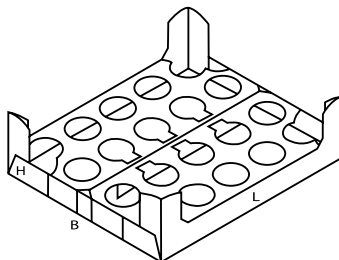
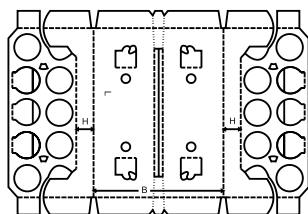

0447

M

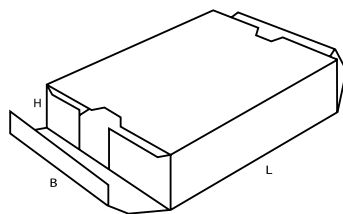
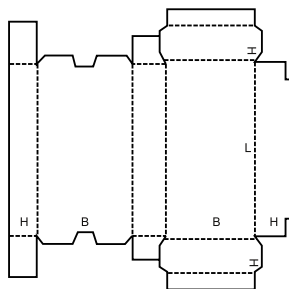

0448

M

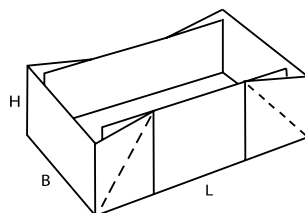
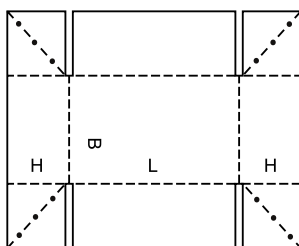

0449

M

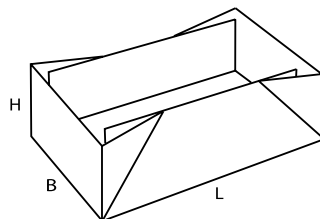
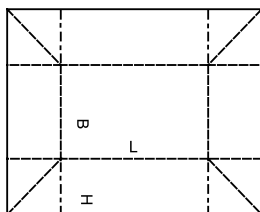

0450

M

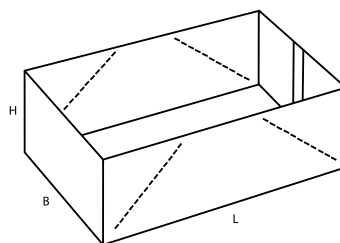
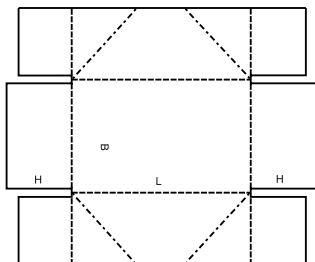

0451

M

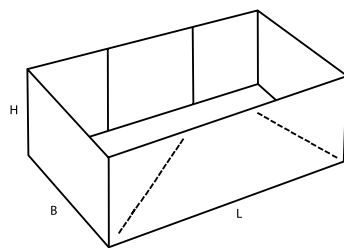
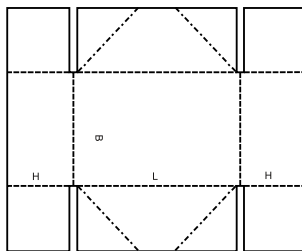

0452

A

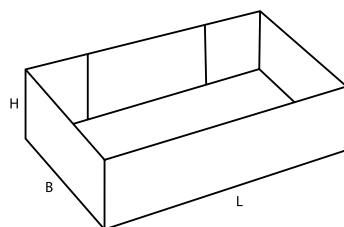
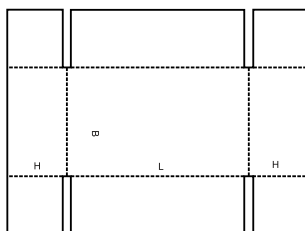

0453

A

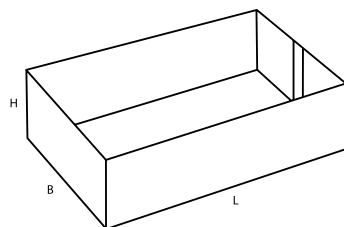
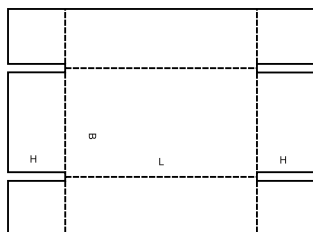

0454

M

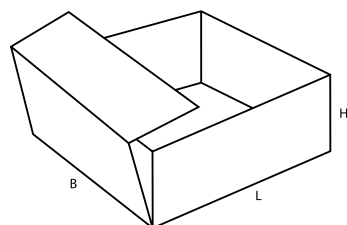
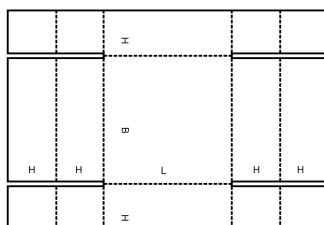

0455

M

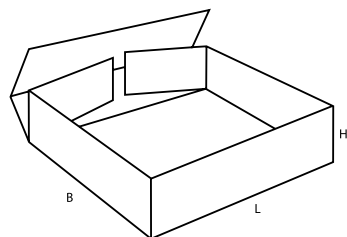
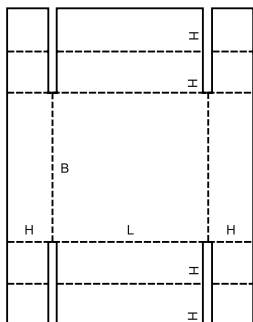

0456

M

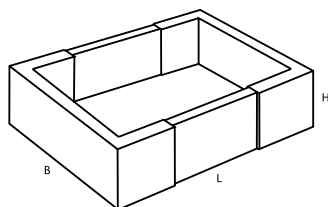
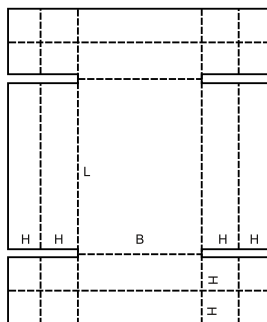

0457

M

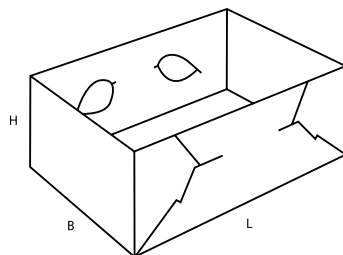
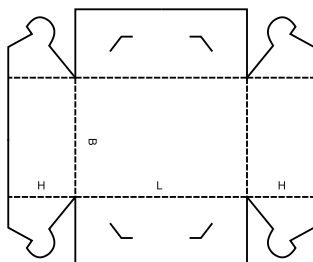

0458

M

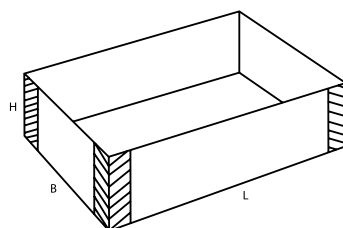
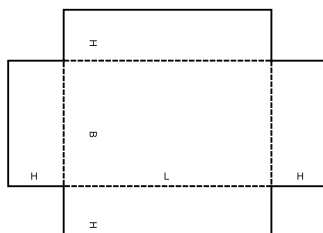

0459

A

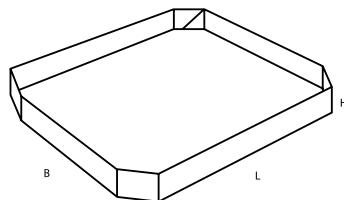
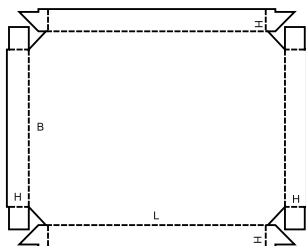

0460

A

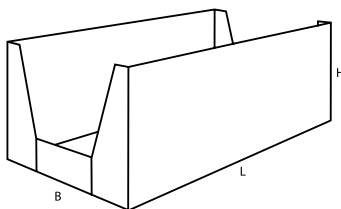
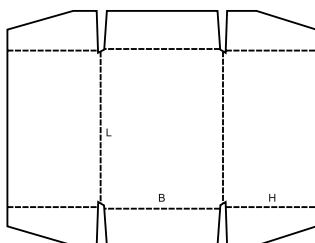

0470

M

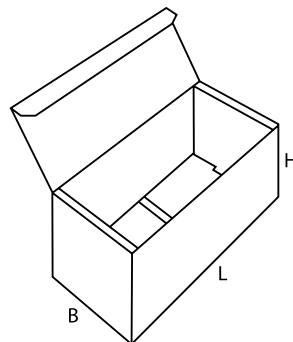
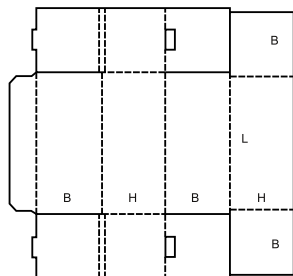

0471

M

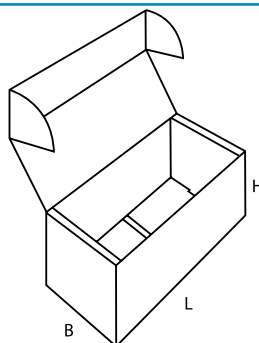
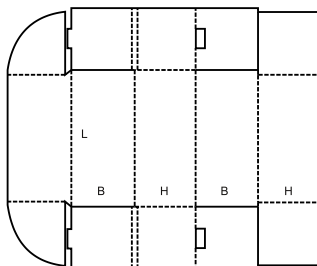

0472

M

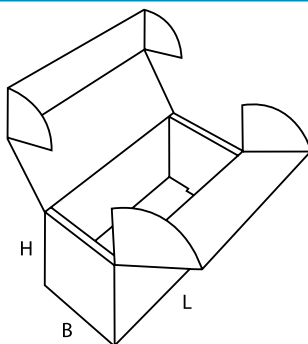
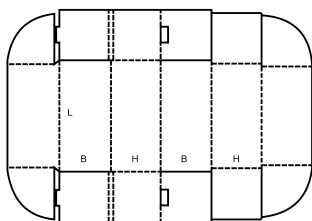

0473

M

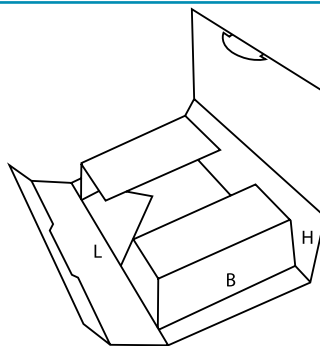
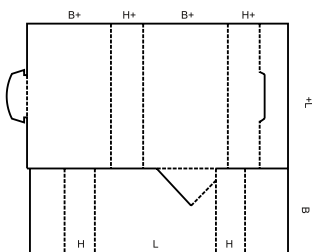



# 0500

▲ **Pudła wsuwane** składają się z większej ilości części (wewnętrznych oraz obwolut), które można w różnych kierunkach wsuwać jedno w drugie. Grupa ta obejmuje także obwoluty dla innych pudeł.

▲ **Slide-type boxes** consist of several pieces of liners and sleeves sliding in different directions into each other. This group also includes outside sleeves for other cases.

0501

M

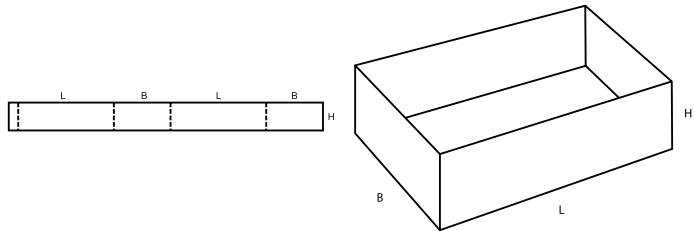

0502

M

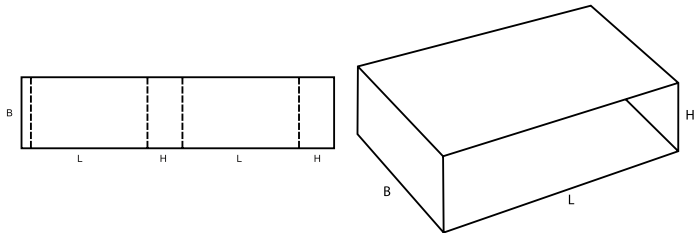

0503

M

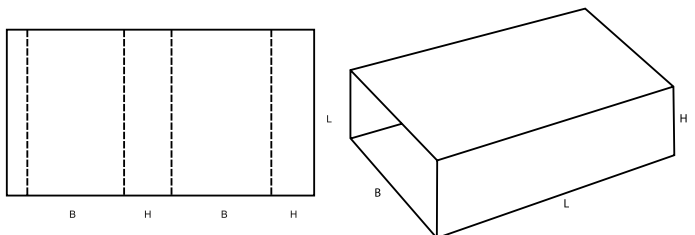

0504

M

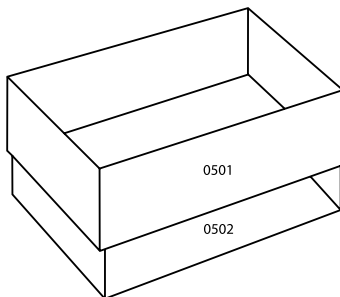
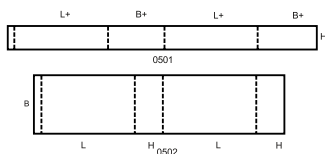

0505

M

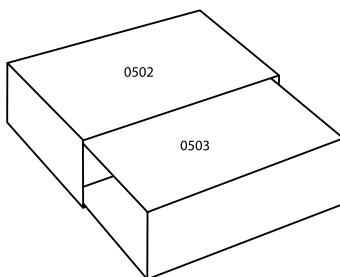
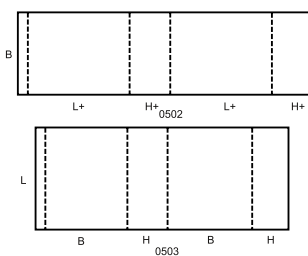

0507

M

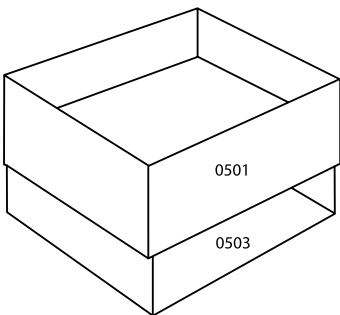
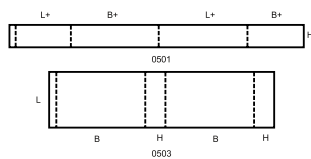

0509

M

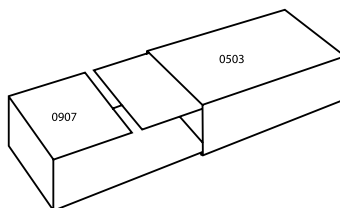
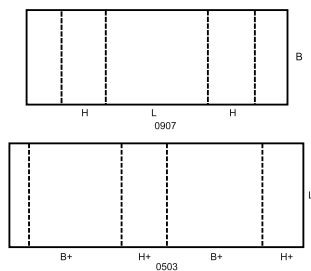

0510

M

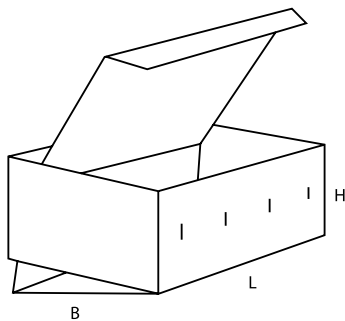
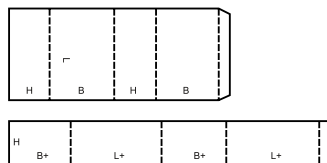

0511

M

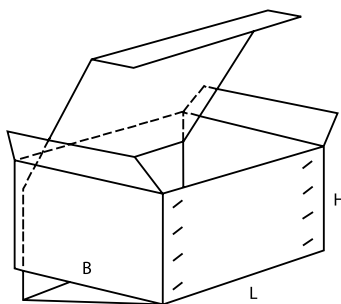
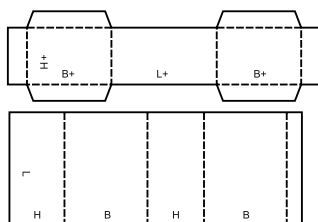

0512

M

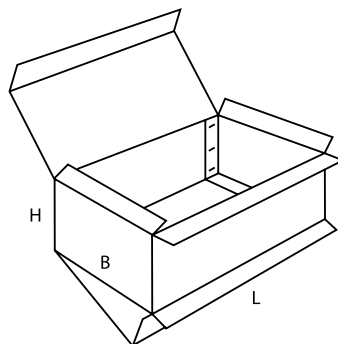
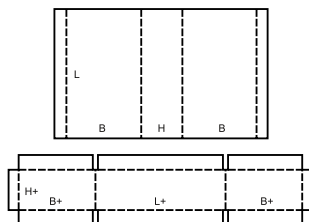

# 0600

▲ **Pudełka trwale łączone** składają się z dwóch oddzielnych części końcowych oraz korpusu i wymagają, przed ich użyciem, zszycia albo podobnej operacji.

▲ **Rigid-type boxes** consist of two separate end pieces and a body and require stitching or a similar operation before they can be used.

0601

A

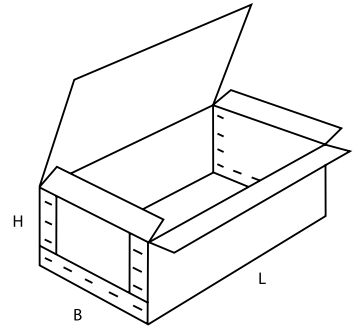
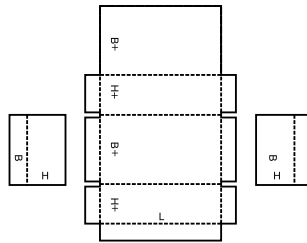

0602

A

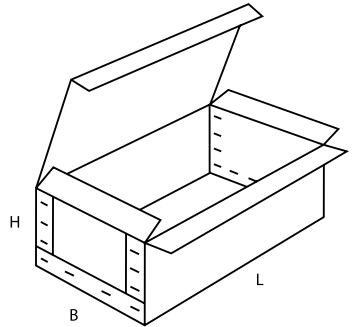
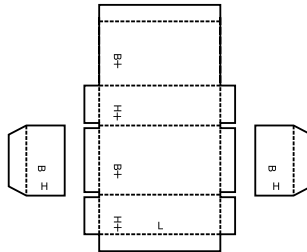

0605

A

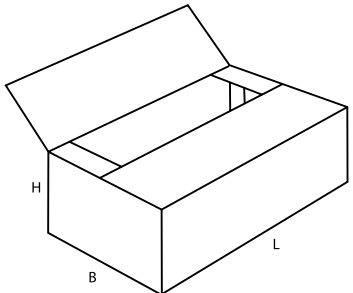
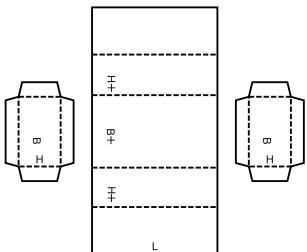

0606

A

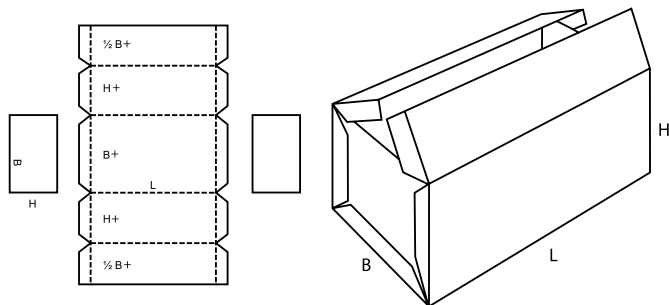

0607

A

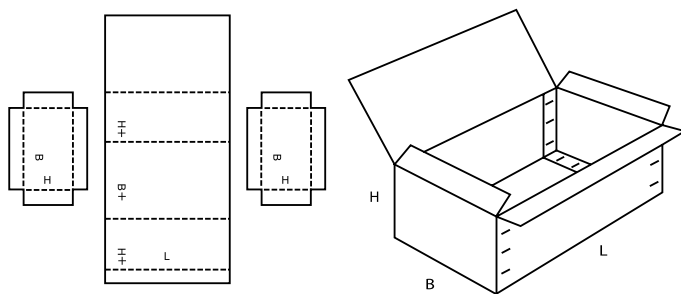

0608

A

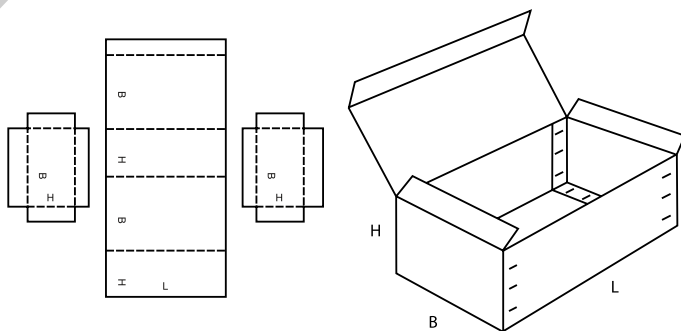

0610

M/A

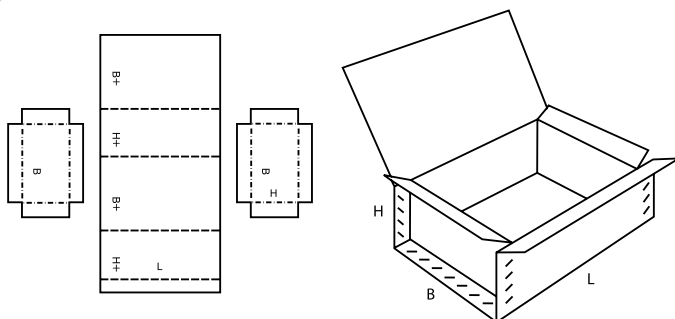

0615

M/A

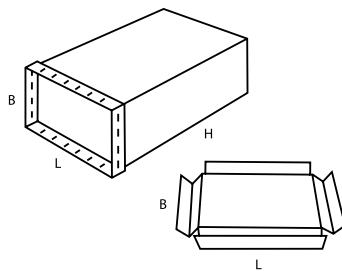
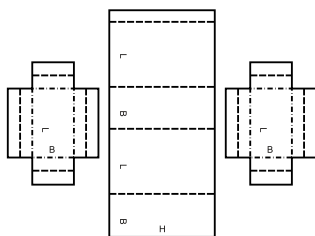

0616

M/A

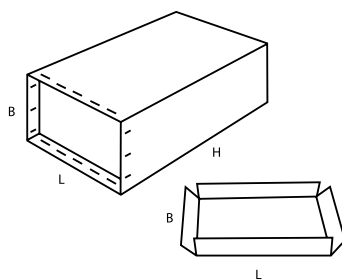
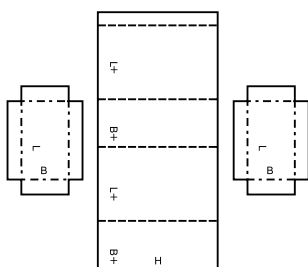

0620

A

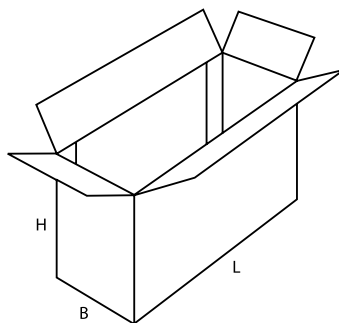
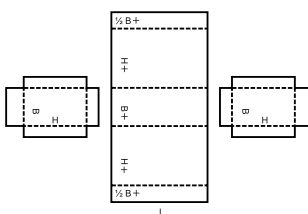

0621

M

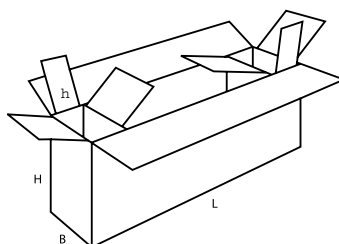
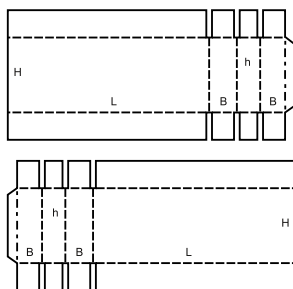

# 0700

▲ **Pudełka klejone jednoczęściowe** są to pudełka klejone, złożone zwykle z jednej części, dostarczane w stanie złożonym i gotowe do użycia po ich prostym rozłożeniu.

▲ **Ready-glued cases** consist of basically one piece, are shipped flat and ready to use by simple setting up.

0700

M

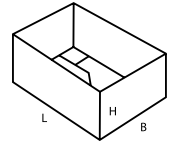
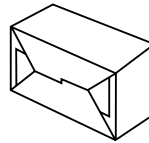
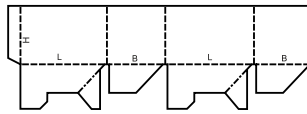

0701

M

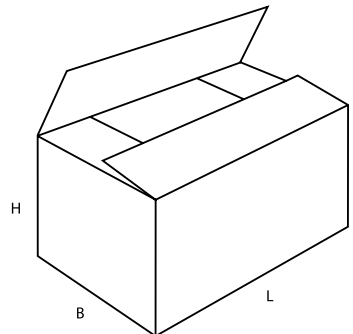
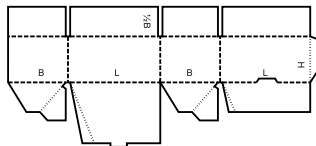

0703

M

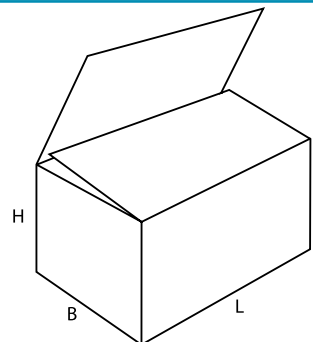
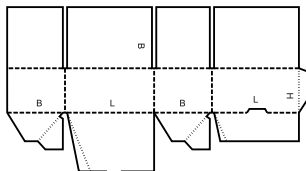

0711

M

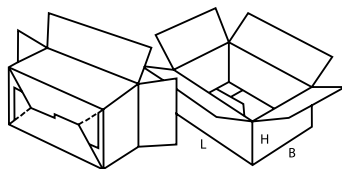
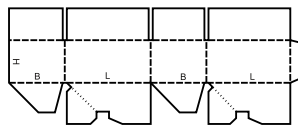

0712

M

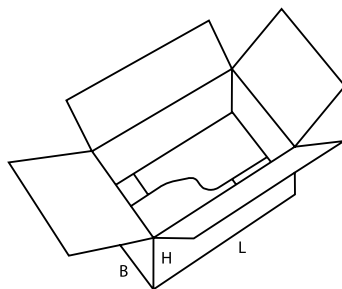
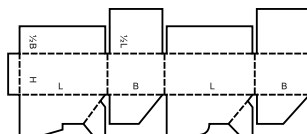

0713

M

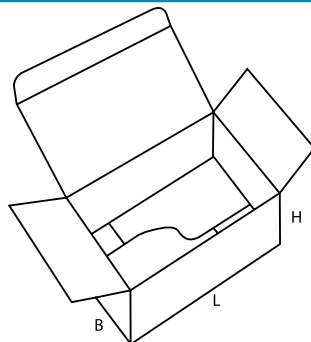
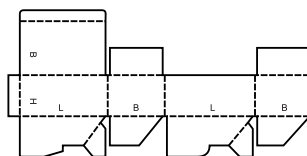

0714

M

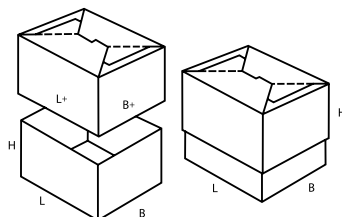
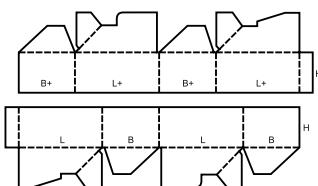



0715

M

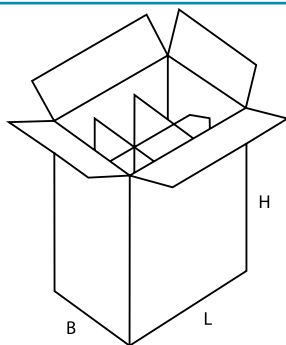
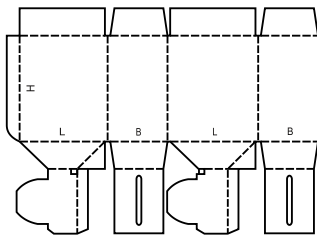

0716

M

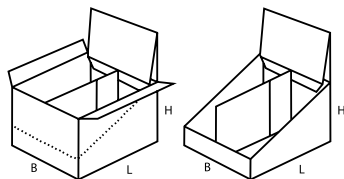
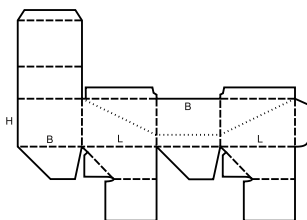

0717

M

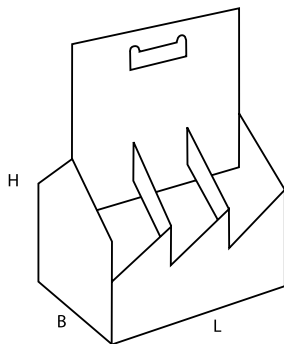
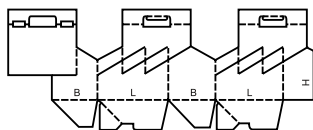

0718

M

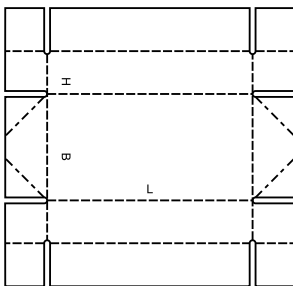

$B \geq 2H$

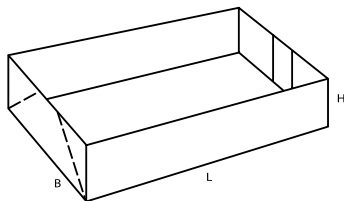

0747

M

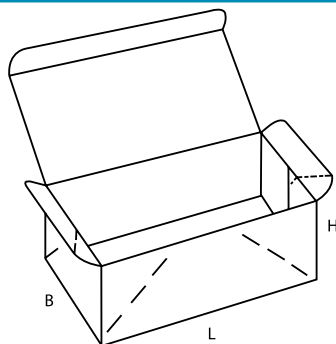
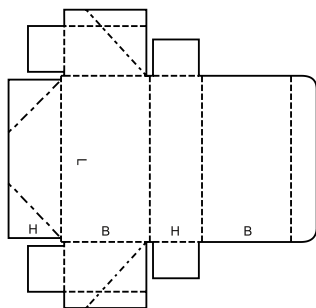

0748

M

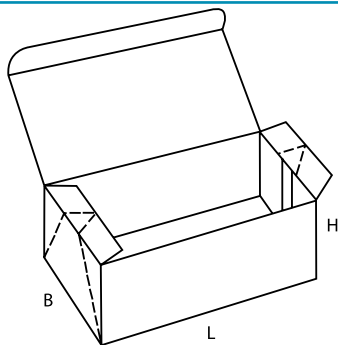
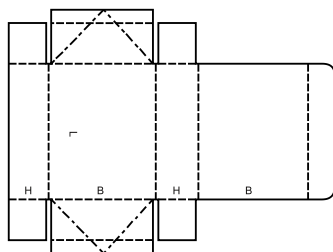

0751

M

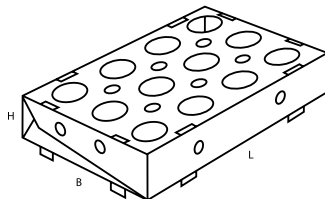
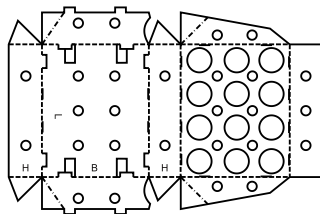

0752

M/A

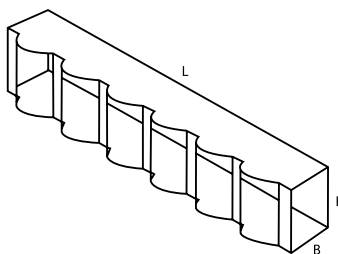
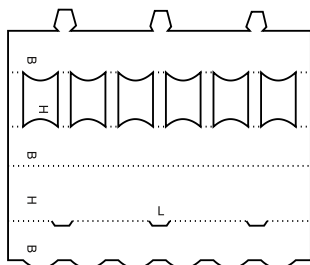

0759

M

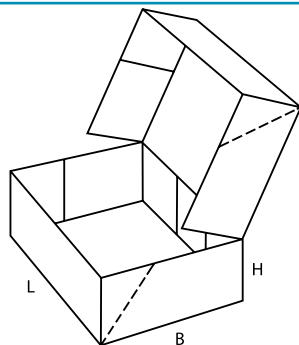
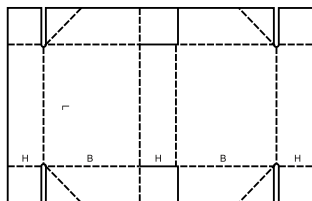

0761

M

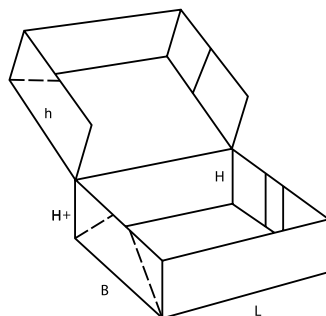
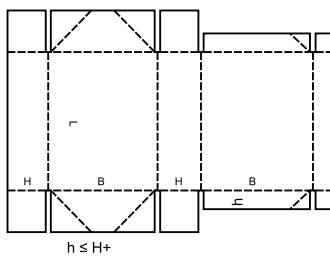

0770

M

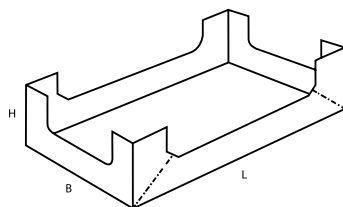
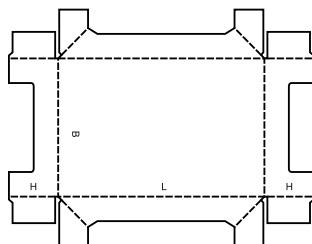

0771

M

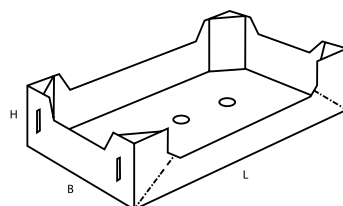
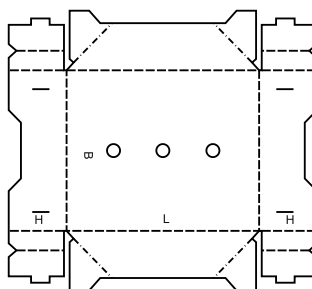

0772

M

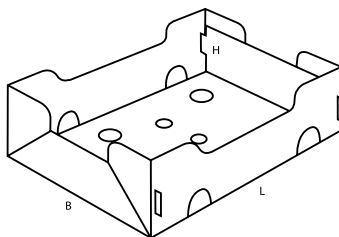
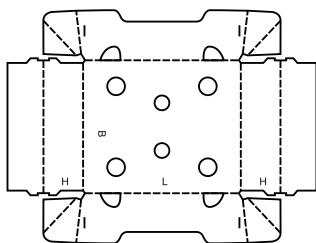

0773

M

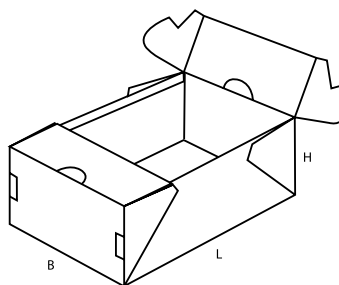
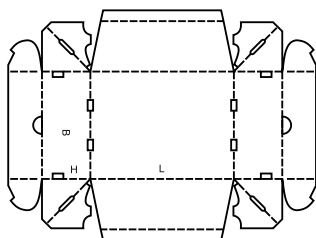

0774

M

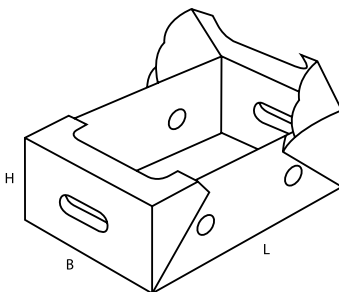
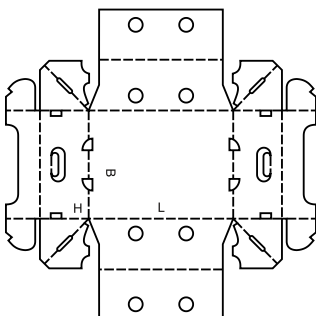

# 0900

▲ **Wyposażenie wewnętrzne** pudeł, takie jak wkładki, przekładki, kratownice, wkładki wypełniające itd., stanowiące elementy związane z konstrukcją pudła albo osobne. Wskazana ilość elementów jest dowolna i może być, stosownie od wymagań, zwiększana lub zmniejszana.

▲ **Interior fittings** such as inside liners, pads, partitions, dividers etc., whether tied to Case Design or as singular items. Any shown number of panels is arbitrary and may be increased or decreased as required.

0900

M

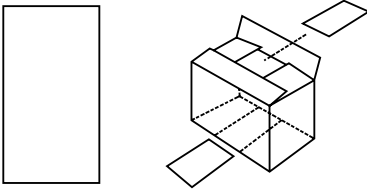

0901

M

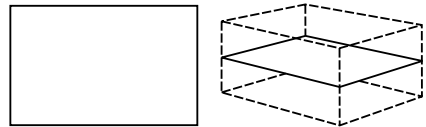

0902

M

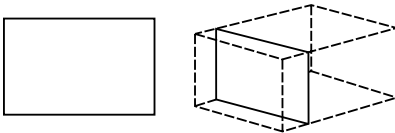

0903

M

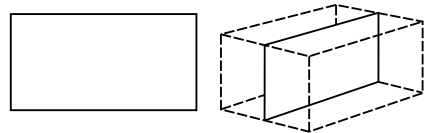

0904

M

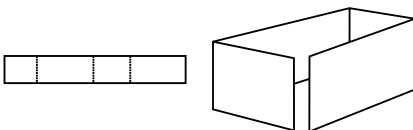

0905

M

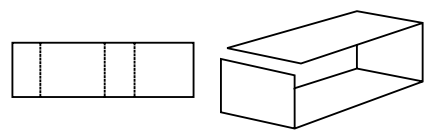

0906

M

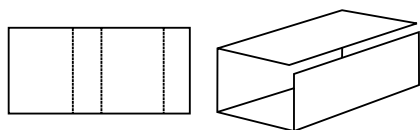

0907

M

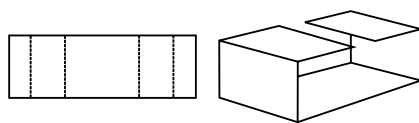

0908

M

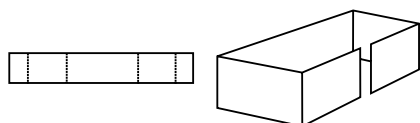

0909

M

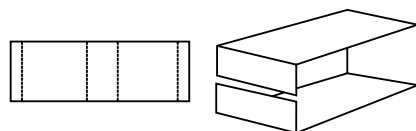

0910

A

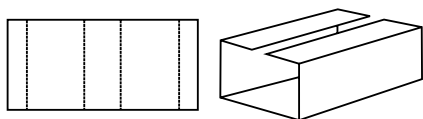

0911

A

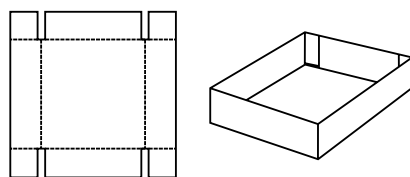

0913

M

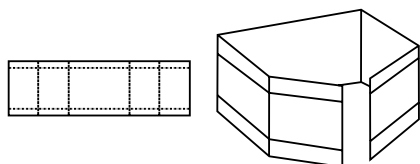

0914

M

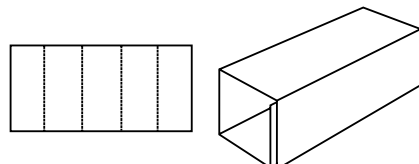

0920

M

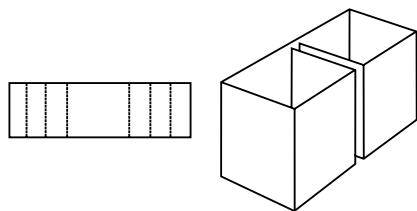

0921

M

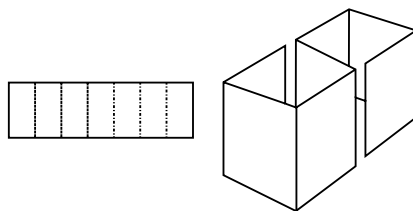

0929

M

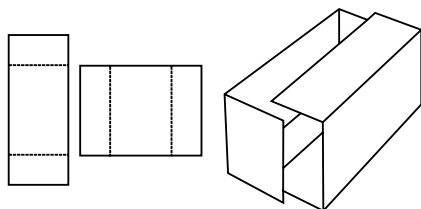

0930

M

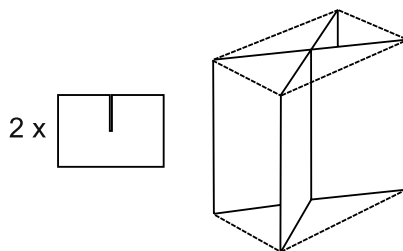

0931

M

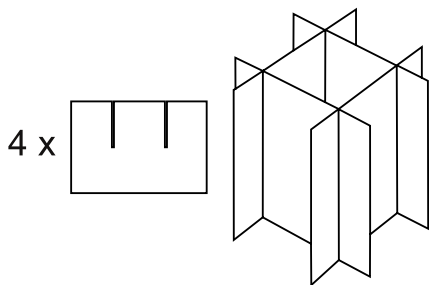

0932

M

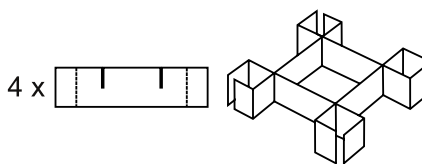

0933

M

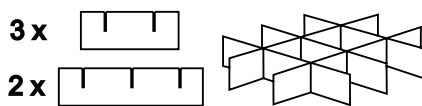

0934

M

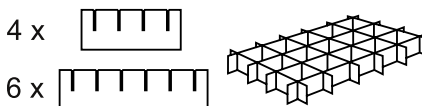

0935

M

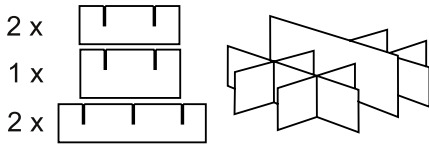

0940

M

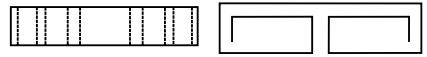

0941

M

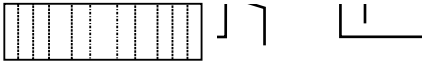

0942

M

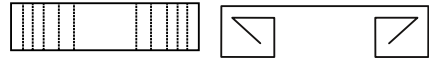

0943

M



0944

M

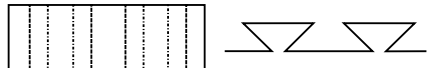

0945

M



0946

M





0947

M



0948

M

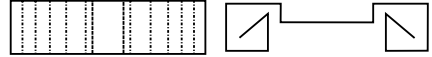

0949

M

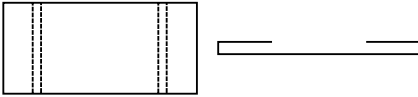

0950

M

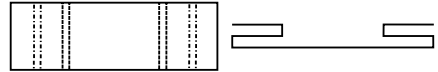

0951

M

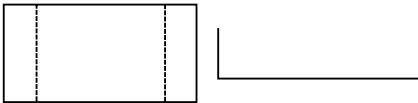

0965

M

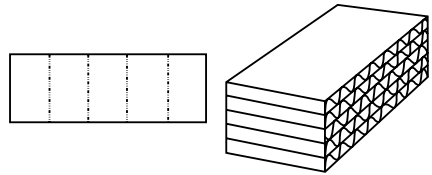

0966

M

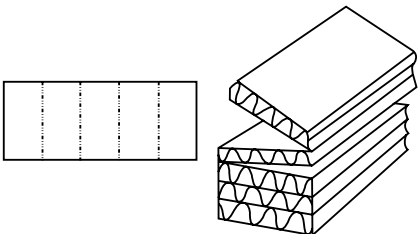

0967

M

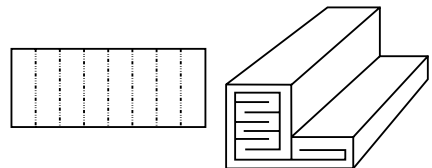

0970

M

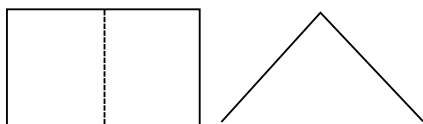

0971

M

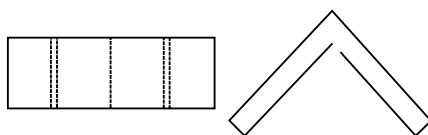

0972

M

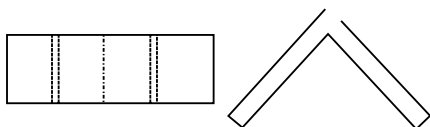

0973

M

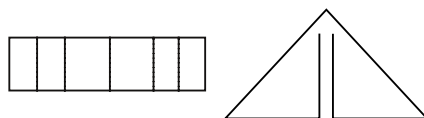

0974

M

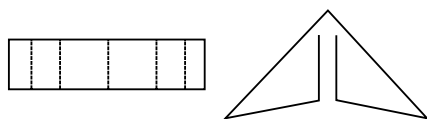

0975

M

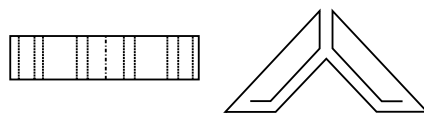

0976

M

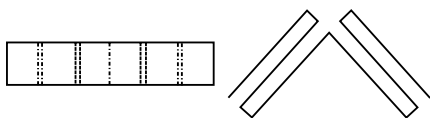

# FEFCO

European Federation of  
Corrugated Board Manufacturers

Avenue Louise 250  
B - 1050 Brussels  
Phone : + 32 2 646 40 70  
Fax : + 32 2 646 64 60  
[www.fefco.org](http://www.fefco.org)  
[information@fefco.org](mailto:information@fefco.org)



[www.fefco.org](http://www.fefco.org)

Member of

**citpa**

**ICA**